



WASHROOM FITTINGS 2017



Architectural Hardware

TOILET PARTITION HARDWARE - HINGES

Gravity Hinge - Screw Fix

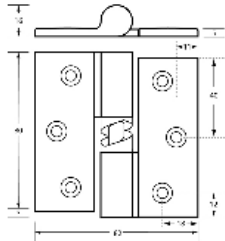

- Diecast zinc, Stainless steel shaft, Nylon inserts

Part No	Description	Finish	Price ea	Price /10	Per
83.40.106 HO LH	Hold Open LH	SC	29.16	\$24.78	pair
83.40.106 HO RH	Hold Open RH	SC	29.16	\$24.78	pair
83.40.106 HC LH	Hold Closed LH	SC	29.16	\$24.78	pair
83.40.106 HC RH	Hold Closed RH	SC	29.16	\$24.78	pair

Gravity Hinge - Bolt Through

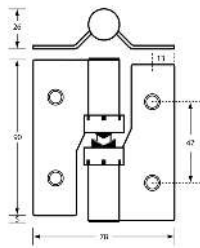

- Stainless steel, Nylon inserts

Part No	Description	Finish	Price ea	Price /10	Per
83.40.206 HO LH	Hold Open LH	SS	\$49.10	\$41.75	pair
83.40.206 HO RH	Hold Open RH	SS	\$49.10	\$41.75	pair
83.40.206 HC LH	Hold Closed LH	SS	\$49.10	\$41.75	pair
83.40.206 HC RH	Hold Closed RH	SS	\$49.10	\$41.75	pair

Concealed Fix Lift-Off Spring Hinge

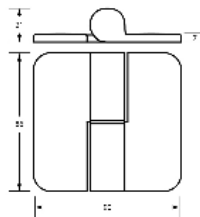

- Diecast zinc, Brass shaft, Nylon inserts
- ABS snap on covers

Part No	Description	Finish	Price ea	Price/10	Per
83.40.105 HO LH	Hold Open LH - Screw Fix	SC	\$44.90	\$38.15	pair
83.40.105 HO RH	Hold Open RH - Screw Fix	SC	\$44.90	\$38.15	pair
83.40.105 HC LH	Hold Closed LH - Screw Fix	SC	\$44.90	\$38.15	pair
83.40.105 HC RH	Hold Closed RH - Screw Fix	SC	\$44.90	\$38.15	pair

Spring Hinge

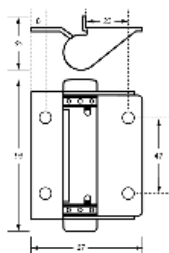

- Stainless steel

Part No	Description	Finish	Price ea	Price /10	Per
83.40.209A HO	With screws - Hold Open	SS	\$50.14	\$42.60	pair
83.40.209A HC	With screws - Hold Closed	SS	\$50.14	\$42.60	pair
83.40.209B HO	Bolt Through - Hold Open	SS	\$69.00	\$58.65	pair
83.40.209B HC	Bolt Through - Hold Closed	SS	\$69.00	\$58.65	pair

TOILET PARTITION HARDWARE - PEDESTAL LEGS

Adjustable Rebated Partition Leg

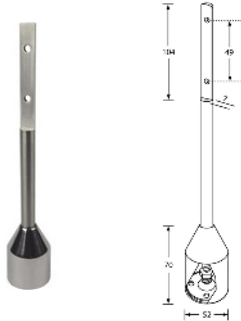

- 50mm adjustment

Part No	Description	Finish	Price ea	Price /10	Per
83.10.150	125mm min - 175mm max height	SS	\$47.40	\$40.29	ea
83.10.200	175mm min - 225mm max height	SS	\$50.76	\$43.15	ea
83.10.250	225mm min - 275mm max height	SS	\$53.28	\$45.29	ea
83.10.300	275mm min - 325mm max height	SS	\$57.90	\$49.20	ea

Adjustable Double Fix Partition Leg

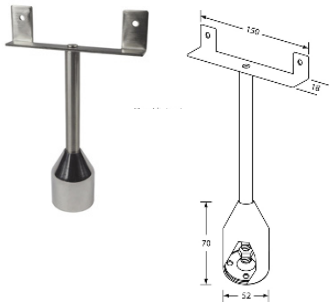

- 50mm adjustment

Part No	Description	Finish	Price ea	Price /10	Per
83.11.150	125mm min - 175mm max height	SS	\$47.00	\$39.95	ea
83.11.200	175mm min - 225mm max height	SS	\$50.34	\$42.79	ea
83.11.250	225mm min - 275mm max height	SS	\$52.46	\$44.59	ea
83.11.300	275mm min - 325mm max height	SS	\$55.80	\$47.43	ea

Adjustable Single Fix Partition Leg

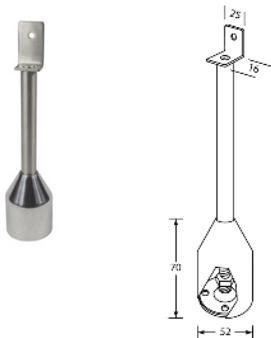

- 50mm adjustment

Part No	Description	Finish	Price ea	Price /10	Per
83.12.150	125mm min - 175mm max height	SS	\$41.12	\$34.95	ea
83.12.200	175mm min - 225mm max height	SS	\$44.48	\$37.80	ea
83.12.250	225mm min - 275mm max height	SS	\$46.58	\$39.60	ea
83.12.300	275mm min - 325mm max height	SS	\$49.94	\$42.45	ea

Adjustable T Piece Partition Leg

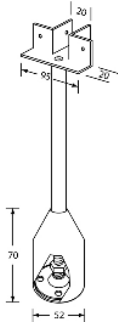

- 50mm adjustment

Part No	Description	Finish	Price ea	Price /10	Per
83.22.150	125mm min - 175mm max height	SS	\$52.86	\$44.93	ea
83.22.200	175mm min - 225mm max height	SS	\$56.22	\$47.79	ea
83.22.250	225mm min - 275mm max height	SS	\$58.32	\$49.57	ea
83.22.300	275mm min - 325mm max height	SS	\$61.68	\$52.43	ea

Adjustable Heavy Duty Aluminium Leg

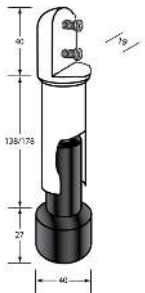

- 40mm adjustment

Part No	Description	Finish	Price ea	Price /10	Per
83.20.165	165mm min - 205mm max height	ALU	\$36.90	\$31.36	ea
83.20.200	185mm min - 225mm max height	ALU	\$39.20	\$33.32	ea

TOILET PARTITION HARDWARE - MISCELLANEOUS

Aluminium Channel



- Interlocks with Aluminium Insert
- To suit 13mm toilet partition

Part No	Description	Finish	Price ea	Price /10	Per
84.13.180	1800mm long	ALU	\$28.32	\$24.07	ea
84.13.300	3000mm long	ALU	\$47.20	\$40.12	ea

- To suit 18mm toilet partition

Part No	Description	Finish	Price ea	Price /10	Per
84.18.180	1800mm long	ALU	\$27.06	\$23.00	ea
84.18.300	3000mm long	ALU	\$44.90	\$38.16	ea



- To suit 33mm toilet partition

Part No	Description	Finish	Price ea	Price /10	Per
84.33.180	1800mm long	ALU	\$35.66	\$30.31	ea
84.33.300	3000mm long	ALU	\$59.48	\$50.56	ea

Aluminium Insert



- Interlocks with Aluminium Channel

Part No	Description	Finish	Price ea	Price /10	Per
85.13.180	Suits 84.13 Channel - 1800mm long	ALU	\$14.16	\$12.04	ea
85.18.200	Suits 84.18 Channel - 2000mm long	ALU	\$16.26	\$13.82	ea
85.33.200	Suits 84.33 Channel - 2000mm long	ALU	\$28.32	\$24.07	ea

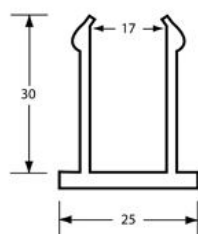

TOILET PARTITION HARDWARE - INDICATOR SETS

Series 100 Lock & Indicator Set

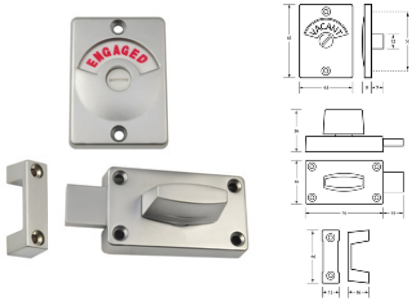

- Diecast zinc
- Screw fix mounting

Part No	Description	Finish	Price ea	Price /20	Per
83.00.100	Indicator Set	SC	\$17.62	\$14.98	ea

Series 200 Indicator Set

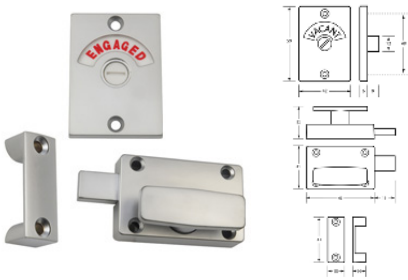

- Diecast zinc
- Screw fix mounting

Part No	Description	Finish	Price ea	Price /20	Per
83.00.200	Indicator Set	SC	\$15.10	\$12.83	ea

Series 300 Indicator Set

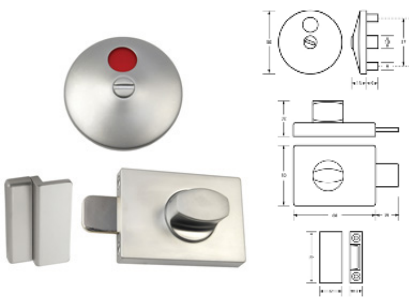

- Concealed fix surface mounted

Part No	Description	Finish	Price ea	Price /20	Per
83.00.301	Indicator Set	SC	\$22.70	\$19.30	ea

Series 700 SS Bumper/Lock Indicator Set

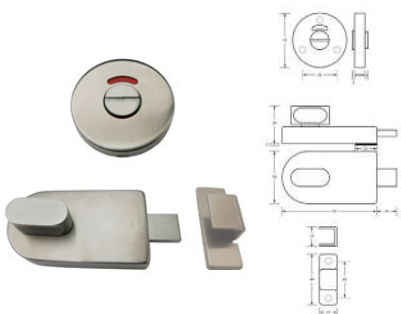

- Stainless Steel
- Concealed fix surface mounted
- Integrated Bumper Stop
- Multiple fixing point for heavy duty use

Part No	Description	Finish	Price ea	Price /20	Per
83.00.700	Bumper/Lock Indicator Set	SS	\$34.60	\$29.41	ea

XCEL Series Slide Lock & Indicator Set

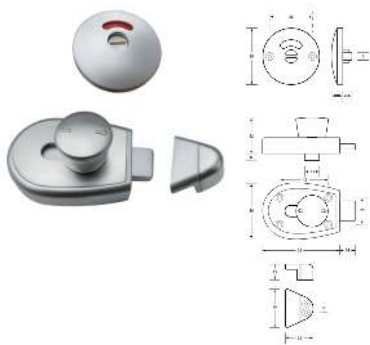

- Diecast Zinc, Concealed screw fix
- Unique easy glide slide lock for restricted hand mobility
- Raised directional arrows for vision impaired

Part No	Description	Finish	Price ea	Price /20	Per
83.00.800	Indicator Set Slide Lock	SC	\$26.22	\$22.28	ea

TOILET PARTITION HARDWARE - STAPLES

Staples



- Brass, SC Finish
- Bolt through

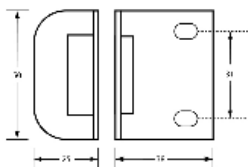

Part No	Description	Finish	Price ea	Price /20	Per
83.03.108	Staple	SC	\$7.12	\$6.05	ea

Z Lift Off Staple



- Brass, SC Finish
- Screw Fix

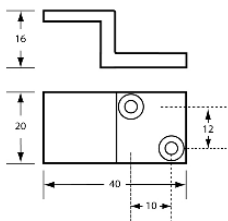

Part No	Description	Finish	Price ea	Price /20	Per
83.03.117	Screw Fix Staple	SC	\$4.62	\$3.93	ea
83.03.117C	Concealed Screw Fix Staple	SC	\$4.20	\$3.57	ea

TOILET PARTITION HARDWARE - BUMPERS

Concealed Fix Bumper

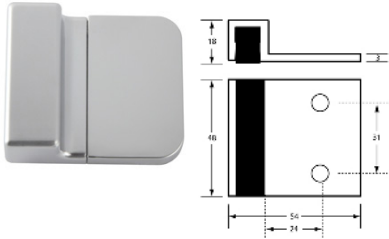

- Diecast Zinc
- Rubber Insert

Part No	Description	Finish	Price ea	Price /20	Per
83.00.101	Concealed Fix Bumper	SC	\$8.80	\$7.48	ea

Bumper

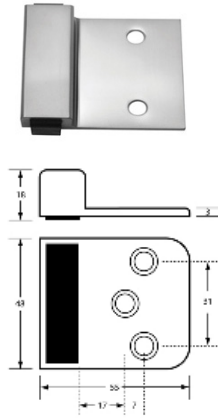

- Brass, SC finish
- Rubber Insert

Part No	Description	Finish	Price ea	Price /20	Per
83.02.101	Screw Fix	SC	\$12.38	\$10.52	ea
83.02.107	Bolt through (includes fittings)	SC	\$15.74	\$13.38	ea

XCEL Series Bumper

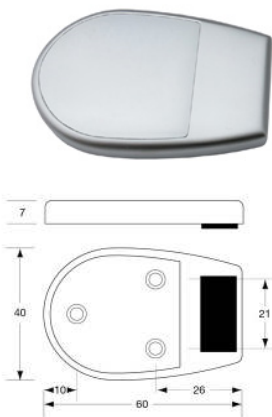

- Diecast Zinc
- Concealed Screw Fix
- Not included with XCEL series indicator set

Part No	Description	Finish	Price ea	Price /20	Per
83.02.108	XCEL Series Bumper	SC	\$8.92	\$7.58	ea

TOILET PARTITION HARDWARE - KITS

Toilet Partition Kit to suit 18mm board - Spring Hinge



Kit Contains:

- 1 pair 83.40.105 Spring Hinges
- 1 x 83.00.301 Indicator
- 1 x 83.01.101 Bumper
- 1 x 83.60.202 Coat Hook
- Fixings

Part No	Description	Finish	Price ea	Price /5	Per
83.50.105 HO LH Kit	Hold Open LH	SC	\$89.60	\$76.16	ea
83.50.105 HO RH Kit	Hold Open RH	SC	\$89.60	\$76.16	ea
83.50.105 HC LH Kit	Hold Closed LH	SC	\$89.60	\$76.16	ea
83.50.105 HC RH Kit	Hold Closed RH	SC	\$89.60	\$76.16	ea

Toilet Partition Kit to suit 18mm board - Gravity Hinge



Kit Contains:

- 1 pair 83.40.106 Gravity Hinge
- 1 x 83.00.100 Indicator
- 1 x 83.02.107 Bumper
- 1 x 83.60.202 Coat Hook
- Fixings

Part No	Description	Finish	Price ea	Price /5	Per
83.50.106 HO LH Kit	Hold Open LH	SC	\$67.00	\$56.95	ea
83.50.106 HO RH Kit	Hold Open RH	SC	\$67.00	\$56.95	ea
83.50.106 HC LH Kit	Hold Closed LH	SC	\$67.00	\$56.95	ea
83.50.106 HC RH Kit	Hold Closed RH	SC	\$67.00	\$56.95	ea

Toilet Partition Kit to suit 18mm board - Gravity Hinge



Kit Contains:

- 1 pair 83.40.206 SS Gravity Hinge
- 1 x 83.00.100 Indicator
- 1 x 83.02.107 Bumper
- 1 x 83.60.202 Coat Hook
- Fixings

Part No	Description	Finish	Price ea	Price /5	Per
83.50.206 HO LH Kit	Hold Open LH	SC	\$94.60	\$80.41	ea
83.50.206 HO RH Kit	Hold Open RH	SC	\$94.60	\$80.41	ea
83.50.206 HC LH Kit	Hold Closed LH	SC	\$94.60	\$80.41	ea
83.50.206 HC RH Kit	Hold Closed RH	SC	\$94.60	\$80.41	ea

COAT HOOKS

102 Screw Fix Coat Hooks



- Diecast Zinc
- Rubber Bumper

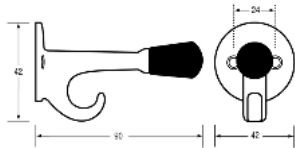

Part No	Description	Finish	Price ea	Price /20	Per
83.60.102	Screw Fix Coat Hook	SC	\$6.72	\$5.71	ea

202 Coat Hooks



- Diecast Zinc
- Rubber Bumper

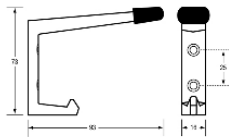

Part No	Description	Finish	Price ea	Price /20	Per
83.60.202	Screw Fix Coat Hook	SC	\$7.34	\$6.24	ea

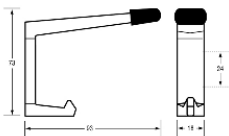

83.60.202C	Concealed Fix Coat Hook	SC	\$8.40	\$7.14	ea
------------	-------------------------	----	--------	--------	----

COAT HOOK WITH BUMPER



- Stainless Steel
- Rubber Bumper

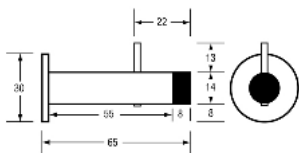

Part No	Description	Finish	Price ea	Price /20	Per
83.60.160	Coat Hook with Bumper, 35 x 30 x 65	SC	\$11.55	\$9.82	ea

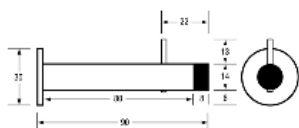

83.60.162	Coat Hook with Bumper, 35 x 30 x 90	SC	\$12.70	\$10.80	ea
-----------	-------------------------------------	----	---------	---------	----

TOILET ROLL HOLDERS

Single Toilet Roll Holder

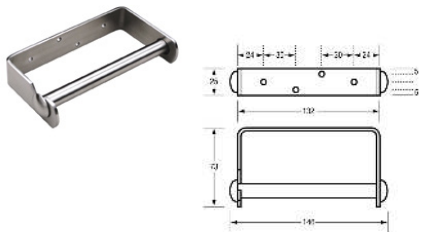

- Surface Mount Visible Fix

Part No	Description	Finish	Price ea	Price /20	Per
83.70.113	Stainless Steel	SS	\$14.80	\$12.58	ea
83.70.513	Aluminium	ALU	\$8.70	\$7.40	ea

Single Toilet Roll Holder

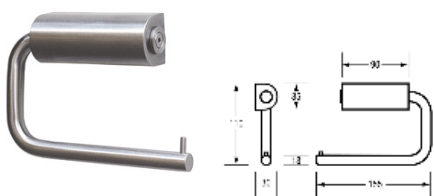

- Surface Mount Security Concealed Fix

Part No	Description	Finish	Price ea	Price /20	Per
83.70.413	Stainless Steel	SS	\$40.10	\$34.09	ea

GRAB RAILS

Straight Grab Rail

- 32mm Ø #304 Stainless Steel
- Concealed Fix - 78mm Ø Mount
- GST exempt

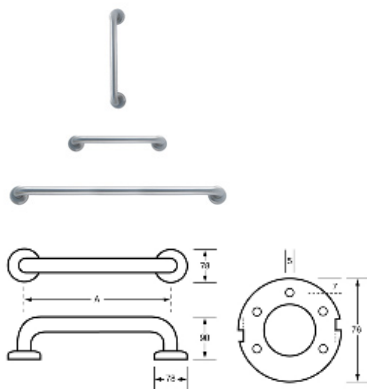

Part No	Description	Finish	Price ea	Price /20	Per
83.80.327	300mm centre to centre	SS	\$30.20	\$27.18	ea
83.80.328	350mm centre to centre	SS	\$30.72	\$27.65	ea
83.80.329	400mm centre to centre	SS	\$31.40	\$28.26	ea
83.80.330	450mm centre to centre	SS	\$33.20	\$29.88	ea
83.80.331	600mm centre to centre	SS	\$34.80	\$31.32	ea
83.80.332	750mm centre to centre	SS	\$39.10	\$35.19	ea
83.80.333	900mm centre to centre	SS	\$43.20	\$38.88	ea

90° Ambulant Grab Rail

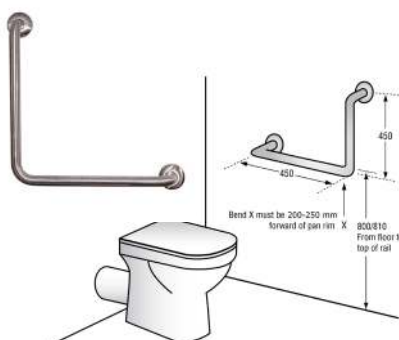

- 32mm Ø #304 Stainless Steel
- Concealed Fix - 78mm Ø Mount
- Suits Right or Left Hand Installation
- GST exempt

Part No	Description	Finish	Price ea	Price /20	Per
83.80.112	450 x 450mm	SS	\$69.90	\$62.91	ea

P 1800 061 787 F 03 6228 7077
SALES@SAHGROUP.COM.AU
26 STATION STREET MOONAH TASMANIA 7009
WWW.SAHGROUP.COM.AU



Architectural Hardware