



FASTENERS, TOOLS & PPE  
2018



Architectural Hardware

## Contents

Chipboard Screws	3-4
Capfit Screws	5
Particleboard Screws	6-8
Euro Screws	8
Panhead Self Tapper Screws	9
Wall Mates	9
Brads & Staples	10-11
Handle Screws	12
Drill Bits	13-17
Holesaws	18
Driver Bits	19
Tools & Accessories	19-22
Safety Equipment (PPE)	23-26

## Chipboard Screws - Phillips Drive

No 2 Phillips Drive

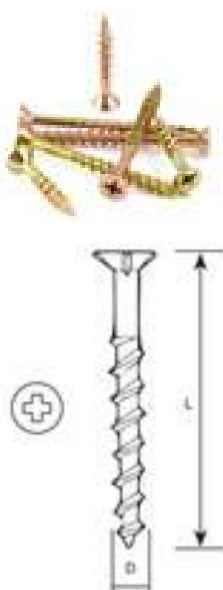

Part No	Description	Finish	Price /1	Price /10	Per
61.00.820 PH	4.2 (8g) x 20mm Chipboard Screws	YZ	\$12.20	\$10.37	1000
61.00.825 PH	4.2 (8g) x 25mm Chipboard Screws	YZ	\$13.75	\$11.68	1000
61.00.828 PH	4.2 (8g) x 28mm Chipboard Screws	YZ	\$15.21	\$12.93	1000
61.00.830 PH	4.2 (8g) x 30mm Chipboard Screws	YZ	\$15.48	\$13.15	1000
61.00.832 PH	4.2 (8g) x 32mm Chipboard Screws	YZ	\$16.07	\$13.66	1000
61.00.835 PH	4.2 (8g) x 35mm Chipboard Screws	YZ	\$18.30	\$15.55	1000
61.00.840 PH	4.2 (8g) x 40mm Chipboard Screws	YZ	\$19.51	\$16.58	1000
61.00.845 PH	4.2 (8g) x 45mm Chipboard Screws	YZ	\$21.10	\$17.94	1000
61.00.850 PH	4.2 (8g) x 50mm Chipboard Screws	YZ	\$22.90	\$19.46	1000
61.00.860 PH	4.2 (8g) x 60mm Chipboard Screws	YZ	\$26.96	\$22.92	1000
61.00.865 PH	4.2 (8g) x 65mm Chipboard Screws	YZ	\$29.15	\$24.77	1000
61.00.1075 PH	4.8 (10g) x 75mm Chip- board Screws	YZ	\$46.41	\$39.45	1000
61.00.1010 PH	4.8 (10g) x 100mm Chip- board Screws	YZ	\$86.38	\$73.42	1000

## Chipboard Screws - Pozi Drive

No 2 Pozi Drive



Part No	Description	Finish	Price /1	Price /10	Per
61.00.820 PZ	4.2 (8g) x 20mm Chipboard Screws	ZP	\$12.20	\$10.37	1000
61.00.825 PZ	4.2 (8g) x 25mm Chipboard Screws	ZP	\$13.75	\$11.68	1000
61.00.828 PZ	4.2 (8g) x 28mm Chipboard Screws	ZP	\$15.21	\$12.93	1000
61.00.830 PZ	4.2 (8g) x 30mm Chipboard Screws	ZP	\$15.48	\$13.15	1000
61.00.832 PZ	4.2 (8g) x 32mm Chipboard Screws	ZP	\$16.07	\$13.66	1000
61.00.835 PZ	4.2 (8g) x 35mm Chipboard Screws	ZP	\$18.30	\$15.55	1000
61.00.840 PZ	4.2 (8g) x 40mm Chipboard Screws	ZP	\$19.51	\$16.58	1000
61.00.845 PZ	4.2 (8g) x 45mm Chipboard Screws	ZP	\$21.10	\$17.94	1000
61.00.850 PZ	4.2 (8g) x 50mm Chipboard Screws	ZP	\$22.90	\$19.46	1000
61.00.860 PZ	4.2 (8g) x 60mm Chipboard Screws	ZP	\$26.96	\$22.92	1000
61.00.865 PZ	4.2 (8g) x 65mm Chipboard Screws	ZP	\$29.15	\$24.77	1000
61.00.1075 PZ	4.8 (10g) x 75mm Chipboard Screws	ZP	\$46.41	\$39.45	1000
61.00.1010 PZ	4.8 (10g) x 100mm Chipboard Screws	ZP	\$86.38	\$73.42	1000

## Capfit Screws - Phillips Drive

No 2 Phillips Drive

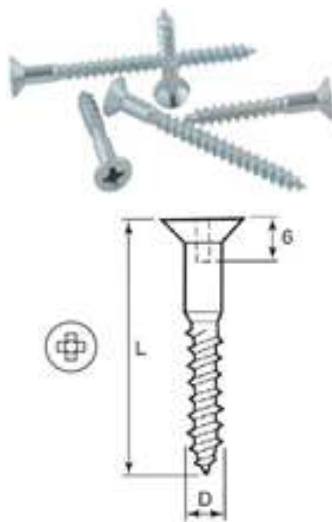

Part No	Description	Finish	Price / 1	Price / 10	Per
61.10.125 PH	4.5 (10g) x 25mm Capfit Screws	ZP	\$34.93	\$29.69	1000
61.10.128 PH	4.5 (10g) x 28mm Capfit Screws	ZP	\$36.05	\$30.64	1000
61.10.130 PH	4.5 (10g) x 30mm Capfit Screws	ZP	\$37.33	\$31.73	1000
61.10.135 PH	4.5 (10g) x 35mm Capfit Screws	ZP	\$39.50	\$33.57	1000
61.10.140 PH	4.5 (10g) x 40mm Capfit Screws	ZP	\$39.85	\$33.87	1000
61.10.150 PH	4.5 (10g) x 50mm Capfit Screws	ZP	\$46.66	\$39.66	1000
61.10.160 PH	4.5 (10g) x 60mm Capfit Screws	ZP	\$52.90	\$44.96	1000
61.10.165 PH	4.5 (10g) x 65mm Capfit Screws	ZP	\$58.00	\$49.30	1000
61.10.175 PH	4.5 (10g) x 75mm Capfit Screws	ZP	\$84.50	\$71.82	1000

## Capfit Screws - Pozi Drive

No 2 Pozi Drive

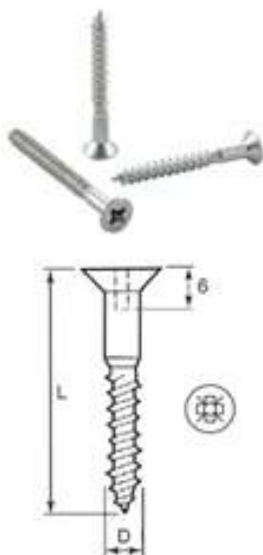

Part No	Description	Finish	Price / 1	Price / 10	Per
61.10.125 PZ	4.5 (10g) x 25mm Capfit Screws	ZP	\$34.93	\$26.69	1000
61.10.128 PZ	4.5 (10g) x 28mm Capfit Screws	ZP	\$36.05	\$30.64	1000
61.10.130 PZ	4.5 (10g) x 30mm Capfit Screws	ZP	\$37.33	\$31.73	1000
61.10.135 PZ	4.5 (10g) x 35mm Capfit Screws	ZP	\$39.50	\$33.57	1000
61.10.140 PZ	4.5 (10g) x 40mm Capfit Screws	ZP	\$39.85	\$33.87	1000
61.10.150 PZ	4.5 (10g) x 50mm Capfit Screws	ZP	\$46.66	\$39.66	1000
61.10.160 PZ	4.5 (10g) x 60mm Capfit Screws	ZP	\$52.90	\$44.96	1000
61.10.165 PZ	4.5 (10g) x 65mm Capfit Screws	ZP	\$58.00	\$49.30	1000
61.10.175 PZ	4.5 (10g) x 75mm Capfit Screws	ZP	\$84.50	\$71.82	1000



## Particleboard Screws - Phillips Drive

No 2 Phillips Drive

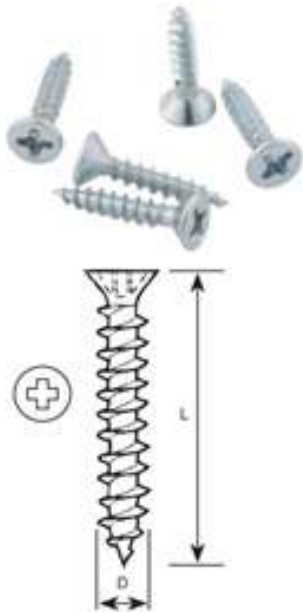

Part No	Description	Finish	Price /1	Price /10	Per
61.20.412 PH	3.0 (4g) x 12mm Particle-board Screws	ZP	\$9.30	\$7.90	1000
61.20.416 PH	3.0 (4g) x 16mm Particle-board Screws	ZP	\$10.00	\$8.50	1000
61.20.420 PH	3.0 (4g) x 20mm Particle-board Screws	ZP	\$11.57	\$9.83	1000
61.20.425 PH	3.0 (4g) x 25mm Particle-board Screws	ZP	\$12.91	\$10.97	1000
61.20.516 PH	3.2 (5g) x 16mm Particle-board Screws	ZP	\$9.00	\$7.65	1000
61.20.612 PH	3.5 (6g) x 12mm Particle-board Screws	ZP	\$8.66	\$7.36	1000
61.20.616 PH	3.5 (6g) x 16mm Particle-board Screws	ZP	\$8.78	\$7.46	1000
61.20.620 PH	3.5 (6g) x 20mm Particle-board Screws	ZP	\$10.07	\$8.56	1000
61.20.625 PH	3.5 (6g) x 25mm Particle-board Screws	ZP	\$10.91	\$9.27	1000
61.20.632 PH	3.5 (6g) x 32mm Particle-board Screws	ZP	\$12.32	\$10.47	1000
61.20.638 PH	3.5 (6g) x 38mm Particle-board Screws	ZP	\$14.28	\$12.14	1000
61.20.816 PH	4.2 (8g) x 16mm Particle-board Screws	ZP	\$11.22	\$9.54	1000
61.20.820 PH	4.2 (8g) x 20mm Particle-board Screws	ZP	\$11.70	\$9.95	1000
61.20.825 PH	4.2 (8g) x 25mm Particle-board Screws	ZP	\$15.38	\$13.07	1000
61.20.828 PH	4.2 (8g) x 28mm Particle-board Screws	ZP	\$19.47	\$16.55	1000
61.20.832 PH	4.2 (8g) x 32mm Particle-board Screws	ZP	\$20.20	\$17.18	1000
61.20.838 PH	4.2 (8g) x 38mm Particle-board Screws	ZP	\$20.37	\$17.31	1000
61.20.845 PH	4.2 (8g) x 45mm Particle-board Screws	ZP	\$24.97	\$21.22	1000
61.20.850 PH	4.2 (8g) x 50mm Particle-board Screws	ZP	\$25.19	\$21.41	1000
61.20.860 PH	4.2 (8g) x 60mm Particle-board Screws	ZP	\$39.93	\$33.94	1000
61.20.865 PH	4.2 (8g) x 65mm Particle-board Screws	ZP	\$44.86	\$38.13	1000

## Particleboard Screws - Pozi Drive

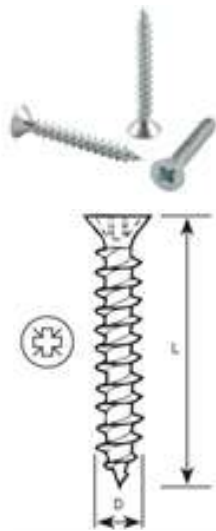

### No 2 Pozi Drive

Part No	Description	Finish	Price /1	Price /10	Per
61.20.412 PZ	3.0 (4g) x 12mm Particle-board Screws	ZP	\$9.30	\$7.90	1000
61.20.416 PZ	3.0 (4g) x 16mm Particle-board Screws	ZP	\$10.01	\$8.51	1000
61.20.420 PZ	3.0 (4g) x 20mm Particle-board Screws	ZP	\$11.57	\$9.83	1000
61.20.425 PZ	3.0 (4g) x 25mm Particle-board Screws	ZP	\$12.91	\$10.97	1000
61.20.516 PZ	3.2 (5g) x 16mm Particle-board Screws	ZP	\$9.00	\$7.65	1000
61.20.612 PZ	3.5 (6g) x 12mm Particle-board Screws	ZP	\$9.75	\$8.30	1000
61.20.616 PZ	3.5 (6g) x 16mm Particle-board Screws	ZP	\$10.01	\$8.50	1000
61.20.620 PZ	3.5 (6g) x 20mm Particle-board Screws	ZP	\$11.83	\$10.07	1000
61.20.625 PZ	3.5 (6g) x 25mm Particle-board Screws	ZP	\$13.99	\$11.90	1000
61.20.632 PZ	3.5 (6g) x 32mm Particle-board Screws	ZP	\$17.25	\$14.66	1000
61.20.638 PZ	3.5 (6g) x 38mm Particle-board Screws	ZP	\$23.10	\$19.63	1000
61.20.816 PZ	4.2 (8g) x 16mm Particle-board Screws	ZP	\$15.06	\$12.80	1000
61.20.820 PZ	4.2 (8g) x 20mm Particle-board Screws	ZP	\$15.90	\$13.53	1000
61.20.825 PZ	4.2 (8g) x 25mm Particle-board Screws	ZP	\$18.32	\$15.57	1000
61.20.828 PZ	4.2 (8g) x 28mm Particle-board Screws	ZP	\$21.82	\$18.55	1000
61.20.832 PZ	4.2 (8g) x 32mm Particle-board Screws	ZP	\$23.80	\$20.23	1000
61.20.838 PZ	4.2 (8g) x 38mm Particle-board Screws	ZP	\$27.01	\$22.96	1000
61.20.845 PZ	4.2 (8g) x 45mm Particle-board Screws	ZP	\$29.33	\$24.93	1000
61.20.850 PZ	4.2 (8g) x 50mm Particle-board Screws	ZP	\$29.50	\$25.07	1000
61.20.860 PZ	4.2 (8g) x 60mm Particle-board Screws	ZP	\$39.93	\$33.94	1000
61.20.865 PZ	4.2 (8g)x 65mm Particle-board Screws	ZP	\$44.86	\$38.13	1000

### Particleboard Screws - Phillips Drive - Brass Plate



No 2 Phillips Drive

Part No	Description	Finish	Price /1	Price /10	Per
61.21.416 PH	3.0 (4g) x 16mm Particle-board Screws	BP	\$13.77	\$12.39	1000
61.21.416 PH	3.2 (5g) x 16mm Particle-board Screws	BP	\$15.47	\$13.93	1000

### Particleboard Screws - Phillips Drive - Florentine Bronze



No 2 Phillips Drive

Part No	Description	Finish	Price /1	Price /10	Per
61.21.416 PH	3.0 (4g) x 16mm Particle-board Screws	FB	13.77	12.39	1000
61.21.416 PH	3.2 (5g) x 16mm Particle-board Screws	FB	15.47	13.93	1000

### Euro Screw Countersunk - Pozi Drive

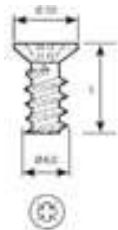

No 2 Pozi Drive

Part No	Description	Finish	Price /1	Price /10	Per
61.63.010 PZ	6.3 x 10mm Euro Screws	NP	\$36.65	\$31.15	1000

### Euro Screw Countersunk - Phillips Drive

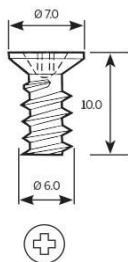

No 2 Phillips Drive

Part No	Description	Finish	Price /1	Price /10	Per
61.63.010 PH	6.3 x 10mm Euro Screws	ZP	\$41.57	\$35.33	1000



## Pan Head Self Tapper Screws

No 2 Phillips Drive

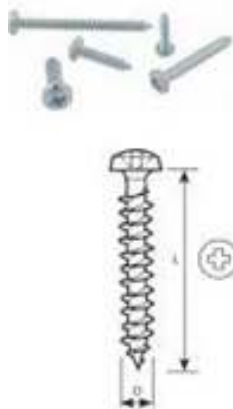

Part No	Description	Finish	Price /1	Price /10	Per
61.30.612 PH	3.5 (6g) x 12mm Pan Head Self Tapper Screw	ZP	\$13.79	\$11.72	1000
61.30.616 PH	3.5 (6g) x 16mm Pan Head Self Tapper Screw	ZP	\$15.07	\$12.81	1000
61.30.620 PH	3.5 (6g) x 20mm Pan Head Self Tapper Screw	ZP	\$17.01	\$14.46	1000
61.30.625 PH	3.5 (6g) x 25mm Pan Head Self Tapper Screw	ZP	\$18.65	\$15.85	1000
61.30.812 PH	4.2 (8g) x 12mm Pan Head Self Tapper Screw	ZP	\$20.30	\$17.25	1000
61.30.816 PH	4.2 (8g) x 16mm Pan Head Self Tapper Screw	ZP	\$22.18	\$18.85	1000
61.30.820 PH	4.2 (8g) x 20mm Pan Head Self Tapper Screw	ZP	\$23.87	\$20.29	1000
61.30.825 PH	4.2 (8g) x 25mm Pan Head Self Tapper Screw	ZP	\$25.26	\$21.47	1000
61.30.112 PH	4.8 (10g) x 12mm Pan Head Self Tapper Screw	ZP	\$28.36	\$24.11	1000
61.30.116 PH	4.8 (10g) x 16mm Pan Head Self Tapper Screw	ZP	\$29.85	\$25.37	1000
61.30.120 PH	4.8 (10g) x 20mm Pan Head Self Tapper Screw	ZP	\$32.87	\$27.94	1000

## Wall Mates



Part No	Description	Finish	Price /1	Price /10	Per
65.00.100	Wall Mate Drywall Anchor - Metal	ZP	\$45.00	\$38.26	100
65.00.101	Wall Mate Drywall Anchor - Nylon	WH	\$45.00	\$38.26	100

## DA Series Brads

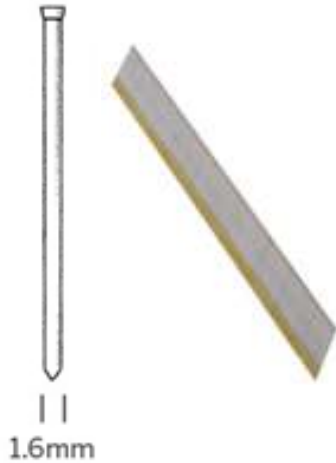

Code	Description	Price /1	Price /10	Per
63.10.013	DA Series Brad 25mm (Box 4000)	\$36.23	\$32.60	Box
63.10.015	DA Series Brad 32mm (Box 4000)	\$41.91	\$37.72	Box
63.10.017	DA Series Brad 38mm (Box 4000)	\$44.73	\$40.26	Box
63.10.019	DA Series Brad 45mm (Box 4000)	\$46.84	\$42.16	Box
63.10.021	DA Series Brad 50mm (Box 4000)	\$51.22	\$46.10	Box
63.10.023	DA Series Brad 57mm (Box 4000)	\$55.39	\$49.84	Box

## C Series Brads (16 Gauge)



Code	Description	Price /1	Price /10	Per
63.16.020	C Series Brads 20 mm (Box of 2500)	\$12.76	\$11.48	Box
63.16.025	C Series Brads 25 mm (Box of 2500)	\$13.18	\$11.86	Box
63.16.030	C Series Brads 30 mm (Box of 2500)	\$14.04	\$12.64	Box
63.16.032	C Series Brads 32mm (Box of 2500)	\$14.91	\$13.41	Box
63.16.035	C Series Brads 35 mm (Box of 2500)	\$15.36	\$13.83	Box
63.16.040	C Series Brads 40 mm (Box of 2500)	\$17.69	\$15.92	Box
63.16.045	C Series Brads 45 mm (Box of 2500)	\$19.25	\$17.32	Box
63.16.050	C Series Brads 50 mm (Box of 2500)	\$19.62	\$17.65	Box

## C100 Series Brads (18 Gauge)



Code	Description	Price /1	Price /10	Per
63.18.010	C100 Series Brads 10mm (Box of 5000)	\$10.82	\$9.73	Box
63.18.015	C100 Series Brads 15mm (Box of 5000)	\$10.82	\$9.73	Box
63.18.020	C100 Series Brads 20mm (Box of 5000)	\$12.52	\$11.27	Box
63.18.025	C100 Series Brads 25mm (Box of 5000)	\$14.61	\$13.15	Box
63.18.030	C100 Series Brads 30mm (Box of 5000)	\$17.25	\$15.53	Box
63.18.035	C100 Series Brads 35mm (Box of 5000)	\$19.34	\$17.41	Box
63.18.040	C100 Series Brads 40mm (Box of 5000)	\$20.59	\$18.53	Box
63.18.045	C100 Series Brads 45mm (Box of 5000)	\$23.25	\$20.92	Box
63.18.050	C100 Series Brads 50mm (Box of 5000)	\$25.48	\$22.93	Box

## 80 Series Staples



Code	Description	Price /1	Price /10	Per
63.80.006	80 Series Staple 6mm (Box of 10,000)	\$15.86	\$14.27	Box
63.80.008	80 Series Staple 8mm (Box of 10,000)	\$17.09	\$15.38	Box
63.80.010	80 Series Staple 10mm (Box of 10,000)	\$9.31	\$8.38	Box
63.80.012	80 Series Staple 12mm (Box of 10,000)	\$10.51	\$9.45	Box
63.80.014	80 Series Staple 14mm (Box of 10,000)	\$11.68	\$10.51	Box

## M4 Handle Screws



Part No	Description	Finish	Price /1	Price /10	Per
63.04.004	M4 Handle Screw - 4mm	ZP	\$25.01	\$22.50	1000
63.04.006	M4 Handle Screw - 6mm	ZP	\$26.58	\$23.92	1000
63.04.008	M4 Handle Screw - 8mm	ZP	\$26.73	\$24.06	1000
63.04.010	M4 Handle Screw - 10mm	ZP	\$26.80	\$24.12	1000
63.04.012	M4 Handle Screw - 12mm	ZP	\$28.05	\$25.24	1000
63.04.016	M4 Handle Screw - 16mm	ZP	\$29.21	\$26.28	1000
63.04.020	M4 Handle Screw - 20mm	ZP	\$31.00	\$27.90	1000
63.04.022	M4 Handle Screw - 22mm	ZP	\$32.80	\$29.52	1000
63.04.025	M4 Handle Screw - 25mm	ZP	\$35.05	\$31.55	1000
63.04.028	M4 Handle Screw - 28mm	ZP	\$35.82	\$32.24	1000
63.04.032	M4 Handle Screw - 32mm	ZP	\$38.17	\$34.35	1000
63.04.035	M4 Handle Screw - 25mm	ZP	\$39.42	\$35.47	1000
63.04.038	M4 Handle Screw - 38mm	ZP	\$41.58	\$37.42	1000
63.04.041	M4 Handle Screw - 41mm	ZP	\$43.05	\$38.74	1000
63.04.045	M4 Handle Screw - 45mm	ZP	\$43.74	\$39.37	1000
63.04.050	M4 Handle Screw - 50mm	ZP	\$45.52	\$40.97	1000

# TOOLS

## Metric Drill Bits



- HSS Titanium Nitride (Gold) Coated which increases the life of the drill
- Drills Metal, Wood & Plastic
- 135 degree split point allows for faster drilling and minimises wandering

Part No	Description	Price /1	Price /10	Per
77.00.010	1.0mm Jobber Drill - cd/2	\$6.60	\$5.28	ea
77.00.015	1.5mm Jobber Drill - cd/2	\$5.85	\$4.68	ea
77.00.020	2.0mm Jobber Drill - cd/2	\$5.60	\$4.48	ea
77.00.025	2.5mm Jobber Drill - cd/2	\$5.60	\$4.48	ea
77.00.030	3.0mm Jobber Drill - cd/2	\$5.25	\$4.20	ea
77.00.035	3.5mm Jobber Drill	\$2.95	\$2.36	ea
77.00.040	4.0mm Jobber Drill	\$3.30	\$2.64	ea
77.00.045	4.5mm Jobber Drill	\$3.60	\$2.88	ea
77.00.050	5.0mm Jobber Drill	\$4.10	\$3.28	ea
77.00.055	5.5mm Jobber Drill	\$4.80	\$3.84	ea
77.00.060	6.0mm Jobber Drill	\$5.60	\$4.48	ea
77.00.065	6.5mm Jobber Drill	\$6.10	\$4.88	ea
77.00.070	7.0mm Jobber Drill	\$7.25	\$5.80	ea
77.00.075	7.5mm Jobber Drill	\$7.90	\$6.32	ea
77.00.080	8.0mm Jobber Drill	\$8.70	\$6.96	ea
77.00.085	8.5mm Jobber Drill	\$9.90	\$7.92	ea
77.00.090	9.0mm Jobber Drill	\$10.85	\$8.68	ea
77.00.095	9.5mm Jobber Drill	\$11.85	\$9.48	ea
77.00.100	10.0mm Jobber Drill	\$13.15	\$10.52	ea

## Imperial Drill Bits



- HSS Titanium Nitride (Gold) Coated which increases the life of the drill
- Drills Metal, Wood & Plastic
- 135 degree split point allows for faster drilling and minimises wandering

Part No	Description	Price /1	Price /10	Per
77.01.100	1/16" Jobber Drill - cd/2	\$5.90	\$4.72	ea
77.01.102	5/64" Jobber Drill - cd/2	\$5.60	\$4.48	ea
77.01.104	3/32" Jobber Drill - cd/2	\$5.60	\$4.48	ea
77.01.106	7/64" Jobber Drill - cd/2	\$5.25	\$4.20	ea
77.01.108	1/8" Jobber Drill - cd/2	\$5.45	\$4.36	ea
77.01.110	9/64" Jobber Drill	\$3.30	\$2.64	ea
77.01.112	5/32" Jobber Drill	\$3.30	\$2.64	ea
77.01.114	11/64" Jobber Drill	\$3.60	\$2.88	ea
77.01.116	3/16" Jobber Drill	\$3.95	\$3.16	ea
77.01.118	13/64" Jobber Drill	\$4.30	\$3.44	ea
77.01.120	7/32" Jobber Drill	\$4.95	\$3.96	ea
77.01.122	15/64" Jobber Drill	\$5.45	\$4.36	ea
77.01.124	1/4" Jobber Drill	\$5.75	\$4.60	ea
77.01.126	17/64" Jobber Drill	\$6.90	\$5.52	ea
77.01.128	9/32" Jobber Drill	\$7.60	\$6.08	ea
77.01.130	19/64" Jobber Drill	\$8.20	\$6.56	ea
77.01.132	5/16" Jobber Drill	\$8.55	\$6.84	ea
77.01.134	21/64" Jobber Drill	\$10.25	\$8.20	ea
77.01.136	11/32" Jobber Drill	\$11.70	\$9.36	ea
77.01.138	23/64" Jobber Drill	\$12.20	\$9.76	ea
77.01.140	3/8" Jobber Drill	\$12.40	\$9.92	ea
77.01.142	25/64" Jobber Drill	\$13.15	\$10.52	ea
77.01.144	13/32" Jobber Drill	\$14.75	\$11.80	ea
77.01.146	27/64" Jobber Drill	\$16.13	\$12.90	ea
77.01.148	7/16" Jobber Drill	\$16.80	\$13.44	ea
77.01.150	29/64" Jobber Drill	\$20.05	\$16.04	ea
77.01.152	15/32" Jobber Drill	\$20.50	\$16.40	ea
77.01.154	31/64" Jobber Drill	\$22.18	\$17.74	ea
77.01.156	1/2" Jobber Drill	\$22.70	\$18.16	ea



## Bull Pack Drills



- HSS Titanium Nitride (Gold) Coated which increases the life of the drill
- Drills Metal, Wood & Plastic
- 135 degree split point allows for faster drilling and minimises wandering

Part No	Description	Price /1	Price /10	Per
77.10.104	3/32" Jobber Drill - pk 10	\$16.30	\$13.04	ea
77.10.106	7/64" Jobber Drill - pk 10	\$17.20	\$13.76	ea
77.10.108	1/8" Jobber Drill - pk 10	\$19.85	\$15.88	ea
77.10.110	9/64" Jobber Drill - pk 10	\$22.30	\$17.84	ea
77.10.010	1.0mm Jobber Drill - pk 10	\$13.65	\$10.92	ea
77.10.015	1.5mm Jobber Drill - pk 10	\$14.20	\$11.36	ea
77.10.020	2.0mm Jobber Drill - pk 10	\$15.50	\$12.40	ea
77.10.025	2.5mm Jobber Drill - pk 10	\$16.30	\$13.04	ea
77.10.030	3.0mm Jobber Drill - pk 10	\$19.85	\$15.88	ea
77.10.032	3.2mm Jobber Drill - pk 10	\$20.40	\$16.32	ea
77.10.035	3.5mm Jobber Drill - pk 10	\$21.25	\$17.00	ea
77.10.040	4.0mm Jobber Drill - pk 10	\$23.70	\$18.96	ea
77.10.045	4.5mm Jobber Drill - pk 10	\$30.75	\$24.60	ea
77.10.050	5.0mm Jobber Drill - pk 10	\$32.55	\$26.04	ea

## Metric Drill Set



- HSS Titanium Nitride (Gold) Coated which increases the life of the drill
- Drills Metal, Wood & Plastic
- 135 degree split point allows for faster drilling and minimises wandering

Part No	Description	Price /1	Price /10	Per
77.60.013	13 pce drill set, sizes 1.5 - 6.5mm	\$34.05	\$27.24	ea
77.60.019	19 pce drill set, sizes 1.0 - 10.0mm	\$85.15	\$68.12	ea
77.60.025	25 pce drill set, sizes 1.0 - 13.0mm	\$170.25	\$136.20	ea

## Imperial Drill Set



- HSS Titanium Nitride (Gold) Coated which increases the life of the drill
- Drills Metal, Wood & Plastic
- 135 degree split point allows for faster drilling and minimises wandering

Part No	Description	Price /1	Price /10	Per
77.60.021	21 pce drill set, sizes 1/16 - 3/8"	\$95.35	\$76.28	ea
77.60.029	29 pce drill set, sizes 1/16 - 1/2"	\$207.70	\$166.16	ea

## TCT Countersink Drill Bit



- Tungsten Carbide Countersink with HSS Drill Bit

Part No	Description	Price /1	Price /10	Per
77.20.106	7/64" Countersink Bit	\$35.50	\$31.95	ea
77.20.108	1/8" Countersink Bit	\$30.00	\$27.00	ea
77.20.110	9/64" Countersink Bit	\$35.50	\$31.95	ea

## Masonry Drill Bit



- Tungsten Carbide Tipped Drill
- Suitable for rotary and impact drilling
- Use for brick, tile, ceramics & concrete

Part No	Description	Price /1	Price /10	Per
77.15.030	3.0 x 70mm Drill	\$5.75	\$4.60	ea
77.15.035	3.5 x 80mm Drill	\$5.75	\$4.60	ea
77.15.040	4.0 x 85mm Drill	\$5.75	\$4.60	ea
77.15.050	5.0 x 85mm Drill	\$5.50	\$4.40	ea
77.15.050L	5.0 x 150mm Drill	\$10.25	\$8.20	ea
77.15.055	5.5 x 85mm Drill	\$5.65	\$4.52	ea
77.15.055L	5.5 x 150mm Drill	\$10.25	\$8.20	ea
77.15.060	6.0 x 100mm Drill	\$5.75	\$4.60	ea
77.15.060L	6.0 x 150mm Drill	\$8.65	\$6.92	ea
77.15.065L	6.5 x 150mm Drill	\$9.85	\$7.88	ea
77.15.070	7.0 x 150mm Drill	\$10.85	\$8.68	ea
77.15.080L	8.0 x 200mm Drill	\$12.00	\$9.60	ea
77.15.100	10.0 x 120mm Drill	\$9.20	\$7.36	ea
77.15.100L	10.0 x 200mm Drill	\$14.75	\$11.80	ea
77.15.120	12.0 x 150mm Drill	\$14.75	\$11.80	ea
77.15.130	13.0 x 150mm Drill	\$17.30	\$13.84	ea
77.15.140	14.0 x 150mm Drill	\$18.30	\$14.64	ea
77.15.160	16.0 x 160mm Drill	\$27.00	\$21.60	ea

## Turbo Bore Spade Bits



- Self Starting Point
- HSS Twist Groove
- Hex Shank prevents slipping in Shank

Part No	Description	Price /1	Price /10	Per
77.12.006	6mm Spade Bit	\$7.40	\$5.92	ea
77.12.008	8mm Spade Bit	\$7.40	\$5.92	ea
77.12.010	10mm Spade Bit	\$8.40	\$6.72	ea
77.12.011	11mm Spade Bit	\$8.40	\$6.72	ea
77.12.012	12mm Spade Bit	\$8.75	\$7.00	ea
77.12.013	13mm Spade Bit	\$8.75	\$7.00	ea
77.12.014	14mm Spade Bit	\$9.25	\$7.40	ea
77.12.016	16mm Spade Bit	\$9.75	\$7.80	ea
77.12.018	18mm Spade Bit	\$10.10	\$8.08	ea
77.12.019	19mm Spade Bit	\$10.60	\$8.48	ea
77.12.020	20mm Spade Bit	\$10.95	\$8.76	ea
77.12.022	22mm Spade Bit	\$11.45	\$9.16	ea
77.12.024	24mm Spade Bit	\$12.10	\$9.68	ea
77.12.025	25mm Spade Bit	\$12.90	\$10.32	ea
77.12.028	28mm Spade Bit	\$12.75	\$10.20	ea
77.12.030	30mm Spade Bit	\$13.10	\$10.48	ea
77.12.032	32mm Spade Bit	\$14.45	\$11.56	ea
77.12.035	35mm Spade Bit	\$14.95	\$11.96	ea
77.12.038	38mm Spade Bit	\$15.30	\$12.24	ea

## Turbo Bore Extension Bar



- Hex Shank prevents slipping in chuck
- Supplied with Allen key

Part No	Description	Price /1	Per
TSO8-EXT 150	150mm 1/4" Extension Bar	\$19.25	ea
TSO8-EXT 300	300mm 1/4" Extension Bar	\$20.45	ea

## Bi-Metal Holesaw



- M42 Cobalt Bi-Metal

Part No	Description	Price /1	Price /10	Per
77.18.016	16mm Holesaw	\$16.80	\$13.44	ea
77.18.019	19mm Holesaw	\$18.15	\$14.52	ea
77.18.020	20mm Holesaw	\$18.50	\$14.80	ea
77.18.022	22mm Holesaw	\$19.15	\$15.32	ea
77.18.025	25mm Holesaw	\$20.15	\$16.12	ea
77.18.029	29mm Holesaw	\$20.85	\$16.68	ea
77.18.032	32mm Holesaw	\$21.50	\$17.20	ea
77.18.035	35mm Holesaw	\$22.85	\$18.28	ea
77.18.038	38mm Holesaw	\$23.55	\$18.84	ea
77.18.040	40mm Holesaw	\$24.05	\$19.24	ea
77.18.044	44mm Holesaw	\$26.55	\$21.24	ea
77.18.048	48mm Holesaw	\$27.60	\$22.08	ea
77.18.051	51mm Holesaw	\$27.60	\$22.08	ea
77.18.054	54mm Holesaw	\$30.95	\$24.76	ea
77.18.057	57mm Holesaw	\$31.25	\$25.00	ea
77.18.060	60mm Holesaw	\$31.95	\$25.56	ea
77.18.064	64mm Holesaw	\$33.60	\$26.88	ea
77.18.067	67mm Holesaw	\$37.00	\$29.60	ea
77.18.070	70mm Holesaw	\$37.30	\$29.84	ea
77.18.076	76mm Holesaw	\$38.65	\$30.92	ea
77.18.083	83mm Holesaw	\$40.35	\$32.28	ea
77.18.089	89mm Holesaw	\$42.00	\$33.60	ea
77.18.092	92mm Holesaw	\$46.05	\$36.84	ea
77.18.102	102mm Holesaw	\$53.10	\$42.48	ea
77.50.008	8 pce Locksmith Holesaw Kit	\$168.10	\$134.48	ea
77.50.012	12 pce Tradesman Holesaw Kit	\$258.90	\$207.12	ea

## Arbors & Pilot Drill



- Quick Release Hex Shank suits 10mm chucks

Part No	Description	Price /1	Price /10	Per
77.18.001	Small Arbor	\$15.15	\$12.88	ea
77.18.002	Large Arbor	\$36.30	\$30.86	ea
77.18.003	Large Quick Release Arbor	\$40.85	\$34.72	ea
77.18.000	89mm Long Pilot Hole Drill for Bi-Metal Holesaws	\$5.45	\$4.63	ea

## Phillips Driver Bits



Part No	Description	Price /1	Price /10	Per
77.35.060	No 1 x 25mm Bit	\$0.77	\$0.62	ea
77.35.061	No 1 x 25mm Ribbed Bit	\$1.08	\$0.86	ea
77.35.050	No 1 x 50mm Bit	\$1.22	\$0.98	ea
77.35.040	No 2 x 25mm Bit	\$0.65	\$0.52	ea
77.35.041	No 2 x 25mm Ribbed Bit	\$1.08	\$0.86	ea
77.35.030	No 2 x 50mm Bit	\$1.22	\$0.98	ea
77.35.031	No 2 x 50mm Ribbed Bit	\$2.31	\$1.85	ea
77.35.020	No 2 x 75mm Bit	\$2.00	\$1.60	ea
77.35.021	No 2 x 75mm Ribbed Bit	\$3.07	\$2.46	ea
77.35.010	No 2 x 100mm Bit	\$2.46	\$1.97	ea
77.35.011	No 2 x 100mm Ribbed Bit	\$4.00	\$3.20	ea
77.35.150	No 2 x 150mm Bit	\$3.69	\$2.95	ea
77.35.151	No 2 x 150mm Ribbed Bit	\$6.76	\$5.41	ea

## Pozi Driver Bit



Part No	Description	Price /1	Price /10	Per
77.35.065	No 1 x 25mm Bit	\$0.77	\$0.62	ea
77.35.050	No 1 x 50mm Bit	\$1.47	\$1.18	ea
77.35.045	No 2 x 25mm Bit	\$0.77	\$0.62	ea
77.35.035	No 2 x 50mm Bit	\$1.22	\$0.98	ea
77.35.025	No 2 x 75mm Bit	\$1.96	\$1.57	ea
77.35.155	No 2 x 150mm Bit	\$3.79	\$3.03	ea

## Ultragrip Retractable Knife



Part No	Description	Price /1	Price /10	Per
77.26.025	Retractable Knife with 3 blades	\$14.90	\$12.65	ea

## 18mm Cutters



Part No	Description	Price /1	Price /10	Per
77.27.018S	Zebra 18mm Large Screw-Lock Cutter	\$13.70	\$11.65	ea
77.27.018A	Zebra 18mm Auto-Lock Cutter	\$13.70	\$11.65	ea
77.28.018S	Rhino-Grip 18mm Large Screw-Lock Cutter	\$7.70	\$6.55	ea
77.28.018A	Rhino-Grip 18mm Large Auto-Lock Cutter	\$7.70	\$6.55	ea

## Heavy Duty Trimming Knife Blade



Part No	Description	Price /1	Price /10	Per
77.27.100	100 Blade Dispenser	\$41.00	\$34.90	ea
77.27.010	10 Blade Dispenser	\$5.50	\$4.46	ea

## 18mm Wide Snap-Off Blade



Part No	Description	Price /1	Price /10	Per
77.27.118	10 Blade Dispenser	\$7.90	\$6.71	ea

## Black Panther Snips - 185mm



Sterling's Black Panther 700 series precision snips are produced to the highest levels of engineering with a total commitment to develop the most durable and refined industrial snip on the market. Ideal for all industrial applications including wire netting, light gauge aluminium, carpet, leather, Kevlar®, and many other items.

- 185mm black handled snips
- Comfort grip ergonomically designed handles
- Stainless Steel serrated edge blades for increased cutting capacity
- Ideal for multiple applications from thin wire to Kevlar®
- Ideal knife replacement tool

Part No	Description	Price /1	Price /10	Per
77.29.000	Black Panther Snips	\$28.30	\$24.05	ea



## Sterling Professional Tape Measure



Part No	Description	Price /1	Price /10	Per
77.30.005	5 metre x 20mm Blade	\$16.75	\$14.24	ea
77.30.008	8 metre x 25mm Blade	\$26.50	\$22.52	ea

## Nicholson Laminate Handi-File



- 200mm
- Single Cut for sharpening and smoothing
- Double Cut for rapid removal and sharpening

Part No	Description	Price /1	Price /10	Per
77.30.010	Handi-File	\$22.90	\$19.46	ea

## Jigsaw Blades



- Ideal for precise straight cuts in hardwoods, softwoods, plywood & plastics
- Euro Shank
- 10 TPI
- 100mm overall length

Part No	Description	Price /1	Price /10	Per
77.23.810	100mm Bi-Metal jigsaw blade - card / 5	\$14.95	\$12.70	card

## Planer Blades



- Suits most electric planes

Part No	Description	Price /1	Price /10	Per
77.23.825	Planer Blades / pr	\$14.00	\$11.90	pr

## Thingamejig Scribing Tool



- Scribes laminates, stone, timber, veneers plus much more
- Single handed use
- Ability to accurately retrace your lines

Part No	Description	Price /1	Price /10	Per
77.30.500	Thingamejig Scribing Tool	\$75.00	\$71.25	ea

## Lightweight Bar Clamp



- Aluminium Clamp

Part No	Description	Price /1	Price /10	Per
77.25.600	520mm Aluminium Clamp	\$19.10	\$17.19	ea
77.25.900	820mm Aluminium Clamp	\$23.30	\$20.97	ea
77.25.120	1120mm Aluminium Clamp	\$28.10	\$25.29	ea
77.25.180	1720mm Aluminium Clamp	\$33.80	\$30.42	ea

## PERSONAL PROTECTION EQUIPMENT (PPE)

### Armourwear Half Frame Polycarbonate Spectacle



- Wraparound, half frame polycarbonate spectacle, padded brow for comfort
- 100% UV Protection, anti-fog & anti-scratch coating
- AS/NZS 1337 Medium Impact approved

Part No	Description	Price /1	Price /5	Per
65.05.000	Clear Safety Spectacles	\$12.00	\$10.20	ea

### Peltor H7A Series Deluxe Earmuffs



- Wide protection range, high level noise areas, SLC80-30d, Class 5
- Padded stainless steel headband, 4 point suspension for comfort
- Liquid gel/foam replaceable ear cushion

Part No	Description	Price /1	Price /5	Per
65.10.006	Peltor H7A Headband Ear-muff + E170	\$33.40	\$30.06	ea

### Spark Plugs® Foam Ear Plugs



SparkPlugs ear plugs are made of extra-soft, extra-light foam. Their tapered shape fits easily into the ear canal, and seals gently and snugly without pressure. They're so comfortable, you'll forget you're wearing earplugs!

SparkPlugs ear plugs offer high SLC (80) 29dB, Class 5 protection

- 100% PVC Free
- Extra-soft, low pressure foam for comfort and fit
- tapered shape for easy insertion and removal

Part No	Description	Price /1	Price /5	Per
65.15.000	Uncorded Earplug (box of 100 pairs)	\$50.70	\$45.63	box

## Corded Ear Plugs



Part No	Description	Price /1	Price /5	Per
65.15.050	Disposable Corded Ear-plugs (Box of 100 pairs)	\$50.70	\$45.63	box

## Black Knight Nitrile Coated Gripmaster Gloves



- Multi-layered Gripmaster technology prevents oil penetration while repelling water ensuring excellent grip
- Anti-Bac antimicrobial treatment provides protection against harmful bacteria and an anti-odour barrier
- 13 gauge lycra/nylon shell provides stretch for a close fit and breathability
- No strikethrough to the inside of the glove to cause irritation or heat build up
- Machine washable increasing glove life without reducing effectiveness of anti-bacterial treatment
- Thin coating ensures superior flexibility and dexterity
- Ideal for handling whiteboard

Part No	Description	Price /1	Price /20	Per
65.35.005	Black Knight Gripmaster Gloves - Size L	\$6.60	\$5.95	pair
65.35.006	Black Knight Gripmaster Gloves - Size XL	\$6.60	\$5.95	pair

## Disposable Vinyl Gloves



Part No	Description	Price /1	Price /5	Per
65.35.000	Disposable Med-X non-powdered gloves (box of 100 pairs)	\$11.00	\$9.35	box

## Sundstrom SR100 Half Mask



- Designed for extended use
- Silicon mask with soft broad nose fit and deep chin cup. Improved vision and balance.
- Use with any sundstrom filter or compressed air attachment
- AS/NZS 1716:2003 approved

Part No	Description	Price /1	Price /5	Per
65.20.100	SR199 Sundstrom Silicone Half Mask	\$84.50	\$76.05	ea

## Sundstrom 218 Gas Filter



- AS/NZS 1716:2003 Approved

Part No	Description	Price /1	Price /5	Per
65.20.025	218-2 Gas Filter	\$35.60	\$32.04	ea

## Sundstrom 510 Particle Filter



- AS/NZS 1716:2003 Approved

Part No	Description	Price /1	Price /5	Per
65.20.020	510 Particle Filter	\$29.10	\$26.19	ea

## Sundstrom Prefilters



- AS/NZS 1716:2003 Approved

Part No	Description	Price /1	Price /5	Per
65.20.042	221-1 Prefilters /pack of 5	\$13.35	\$12.70	pack
65.20.043	221-1 Prefilters /80 box	\$60.70	\$54.63	box

## SuperOne P1 Respirator - Dust & Mist Protection



- Strong Polyester Outer Shell - Thermoformed 230g/m<sup>2</sup>
- Ultra Soft Inner Layer-Spun bond 40g/m<sup>2</sup>
- Pre formed upper part of masks ensures excellent fit & leak tightness
- Large Inner volume offers comfort & increased communication
- Crush resistant
- Welded Straps ensure a more comfortable respirator
- Certified to AS/NZS 1716:2012 License No: 20583 for effective protection against mechanically-generated dusts and mists.
- Exhalation Valve (Part No. 65.20.843) provides increased comfort in hot and dusty work environment

Part No	Description	Price /1	Price /5	Per
65.20.842	SuperOne P1 Respirator - No Valve (20 per box)	\$21.45	\$19.10	Box
65.20.843	SuperOne P1 Respirator - With Valve (20 per box)	\$32.25	\$28.70	Box

## SuperOne P2 Respirator - Dust, Mist & Fume Protection



- Strong Polyester Outer Shell - Thermoformed 230g/m<sup>2</sup>
- Ultra Soft Inner Layer-Spun bond 40g/m<sup>2</sup>
- Pre formed upper part of masks ensures excellent fit & leak tightness
- Large Inner volume offers comfort & increased communication
- Crush resistant
- Welded Straps ensure a more comfortable respirator
- Certified to AS/NZS 1716:2012 License No: 20583 for effective protection against mechanically-generated dusts, mists and fumes.
- Exhalation Valve (Part No. 65.20.846) provides increased comfort in hot and dusty work environment

Part No	Description	Price /1	Price /5	Per
65.20.844	SuperOne P2 Respirator - No Valve (20 per box)	\$24.30	\$21.60	Box
65.20.846	SuperOne P2 Respirator - With Valve (20 per box)	\$35.50	\$31.60	Box





P 1800 061 787 F 03 6228 7077  
SALES@SAHGROUP.COM.AU  
26 STATION STREET MOONAH TASMANIA 7009  
[WWW.SAHGROUP.COM.AU](http://WWW.SAHGROUP.COM.AU)



*Architectural Hardware*