

FASTENERS & ACCESSORIES



FASTENERS & ACCESSORIES

FASTENERS

Chipboard Screws	4-5
Capfit Screws	6
Particleboard Screws	7-8
Euro & Assembly Screw	9
Cover Caps	10
Colour Chart	11
M4 Handle Screws	12
Brads & Staples	13

TOOLS

Metric Drills Bits	14
Imperial Drill Bits	15
Drill Packs & Sets	16
Drill Bits	17
Driver Bits	17
Jigsaw Blades	17
Planar Blades	17
Thingamejig Scribing Tool	17

Chipboard Screws - Phillips Drive

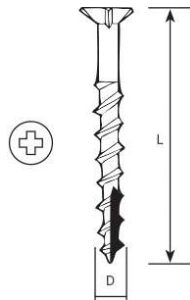

No 2 Phillips Drive

Part No	Description	Finish	Price /1	Price /10	Per
61.00.820.PH	8g x 20mm Chipboard Screw PH	YZ	\$12.29	\$11.09	1000
61.00.825.PH	8g x 25mm Chipboard Screw PH	YZ	\$12.49	\$11.28	1000
61.00.828.PH	8g x 28mm Chipboard Screw PH	YZ	\$14.45	\$13.05	1000
61.00.830.PH	8g x 30mm Chipboard Screw PH	YZ	\$14.69	\$13.26	1000
61.00.832.PH	8g x 32mm Chipboard Screw PH	YZ	\$15.35	\$13.86	1000
61.00.835.PH	8g x 35mm Chipboard Screw PH	YZ	\$16.28	\$14.70	1000
61.00.840.PH	8g x 40mm Chipboard Screw PH	YZ	\$19.60	\$17.69	1000
61.00.845.PH	8g x 45mm Chipboard Screw PH	YZ	\$19.78	\$17.86	1000
61.00.850.PH	8g x 50mm Chipboard Screw PH	YZ	\$23.25	\$20.99	1000
61.00.860.PH	8g x 60mm Chipboard Screw PH	YZ	\$24.27	\$21.91	1000
61.00.865.PH	8g x 65mm Chipboard Screw PH	YZ	\$24.63	\$22.11	1000
61.00.1075. PH	10g x 75mm Chipboard Screw PH	YZ	\$25.34	\$22.73	1000

Chipboard Screws - Pozi Drive

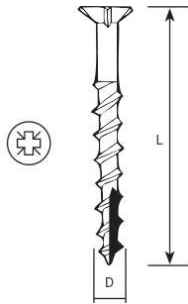

No 2 Pozi Drive

Part No	Description	Finish	Price /1	Price /10	Per
61.00.825.PZ	8g x 25mm Chipboard Screw PZ	YZ	\$11.85	\$10.69	1000
61.00.828.PZ	8g x 28mm Chipboard Screw PZ	YZ	\$12.96	\$11.70	1000
61.00.830.PZ	8g x 30mm Chipboard Screw PZ	YZ	\$13.50	\$12.19	1000
61.00.832.PZ	8g x 32mm Chipboard Screw PZ	YZ	\$13.94	\$12.59	1000
61.00.835.PZ	8g x 35mm Chipboard Screw PZ	YZ	\$17.82	\$16.09	1000
61.00.840.PZ	8g x 40mm Chipboard Screw PZ	YZ	\$18.48	\$16.68	1000
61.00.845.PZ	8g x 45mm Chipboard Screw PZ	YZ	\$19.78	\$17.86	1000
61.00.850.PZ	8g x 50mm Chipboard Screw PZ	YZ	\$23.24	\$20.98	1000
61.00.865.PZ	8g x 65mm Chipboard Screw PZ	YZ	\$24.49	\$21.35	1000
61.00.1075.PZ	10g x 75mm Chipboard Screw PZ	YZ	\$25.38	\$22.21	1000

Capfit Screws - Phillips Drive

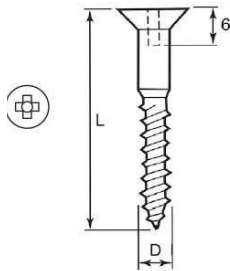

No 2 Phillips Drive

Part No	Description	Finish	Price /1	Price /10	Per
61.10.128.PH	4.5 x 28mm Capfit Screw PH	ZP	\$20.75	\$18.73	1000
61.10.130.PH	4.5 x 30mm Capfit Screw PH	ZP	\$21.20	\$19.14	1000
61.10.140.PH	4.5 x 40mm Capfit Screw PH	ZP	\$23.44	\$21.16	1000
61.10.150.PH	4.5 x 50mm Capfit Screw PH	ZP	\$31.24	\$28.20	1000

Capfit Screws - Pozi Drive

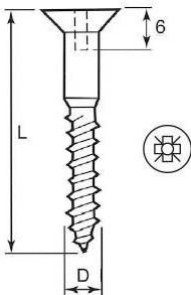

No 2 Pozi Drive

Part No	Description	Finish	Price /1	Price /10	Per
61.10.128.PZ	4.5 x 28mm Capfit Screw PZ	ZP	\$22.83	\$20.61	1000
61.10.130.PZ	4.5 x 30mm Capfit Screw PZ	ZP	\$23.32	\$21.05	1000
61.10.140.PZ	4.5 x 40mm Capfit Screw PZ	ZP	\$25.57	\$23.08	1000
61.10.150.PZ	4.5 x 50mm Capfit Screw PZ	ZP	\$33.83	\$30.54	1000

Particleboard Screws - Phillips Drive

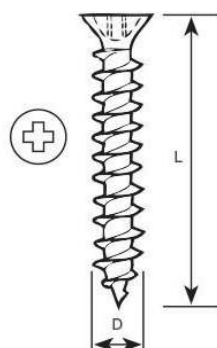

No 2 Phillips Drive

Part No	Description	Finish	Price /1	Price /10	Per
61.20.412.PH	4g x 12mm Particleboard Screw PH	ZP	\$6.52	\$5.88	1000
61.20.516.PH	5g x 16mm Particleboard Screw PH	ZP	\$5.21	\$4.71	1000
61.20.612.PH	6g x 12mm Particleboard Screw PH	ZP	\$10.17	\$9.18	1000
61.20.616 PH	6g x 16mm Particleboard Screw PH	ZP	\$6.36	\$5.74	1000
61.20.620 PH	6g x 20mm Particleboard Screw PH	ZP	\$7.38	\$6.66	1000
61.20.625 PH	6g x 25mm Particleboard Screw PH	ZP	\$9.83	\$8.88	1000
61.20.632 PH	6g x 32mm Particleboard Screw PH	ZP	\$11.74	\$10.60	1000
61.20.640 PH	6g x 40mm Particleboard Screw PH	ZP	\$10.20	\$9.21	1000
61.20.816 PH	8g x 16mm Particleboard Screw PH	ZP	\$8.04	\$7.26	1000
61.20.820 PH	8g x 20mm Particleboard Screw PH	ZP	\$8.38	\$7.56	1000
61.20.825 PH	8g x 25mm Particleboard Screw PH	ZP	\$10.10	\$9.12	1000
61.20.828 PH	8g x 28mm Particleboard Screw PH	ZP	\$10.93	\$9.87	1000
61.20.832 PH	8g x 32mm Particleboard Screw PH	ZP	\$12.15	\$10.97	1000
61.20.845 PH	8g x 45mm Particleboard Screw PH	ZP	\$16.40	\$14.80	1000
61.20.850 PH	8g x 50mm Particleboard Screw PH	ZP	\$16.64	\$15.02	1000
61.20.860 PH	8g x 60mm Particleboard Screw PH	ZP	\$21.42	\$19.34	1000

Particleboard Screws - Pozi Drive

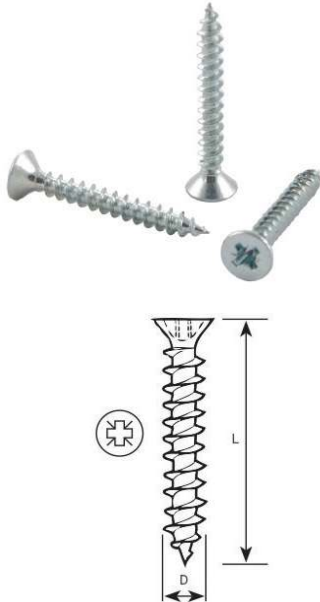

No 2 Pozi Drive

Part No	Description	Finish	Price /1	Price /10	Per
61.20.616 PZ	6g x 16mm Particleboard Screw PZ	ZP	\$7.97	\$7.20	1000
61.20.620 PZ	6g x 20mm Particleboard Screw PZ	ZP	\$10.07	\$9.09	1000
61.20.625 PZ	6g x 25mm Particleboard Screw PZ	ZP	\$12.15	\$10.97	1000
61.20.632 PZ	6g x 32mm Particleboard Screw PZ	ZP	\$14.15	\$12.77	1000
61.20.640 PZ	6g x 40mm Particleboard Screw PZ	ZP	\$15.57	\$14.06	1000
61.20.825 PZ	8g x 25mm Particleboard Screw PZ	ZP	\$9.29	\$8.39	1000
61.20.832 PZ	8g x 32mm Particleboard Screw PZ	ZP	\$11.20	\$10.11	1000
61.20.840 PZ	8g x 40mm Particleboard Screw PZ	ZP	\$11.83	\$10.68	1000
61.20.845 PZ	8g x 45mm Particleboard Screw PZ	ZP	\$16.33	\$14.74	1000
61.20.850 PZ	8g x 50mm Particleboard Screw PZ	ZP	\$21.98	\$19.85	1000
61.20.860 PZ	8g x 60mm Particleboard Screw PZ		\$30.46	\$27.50	1000

Particleboard Screws - Phillips Drive - Electro Brass

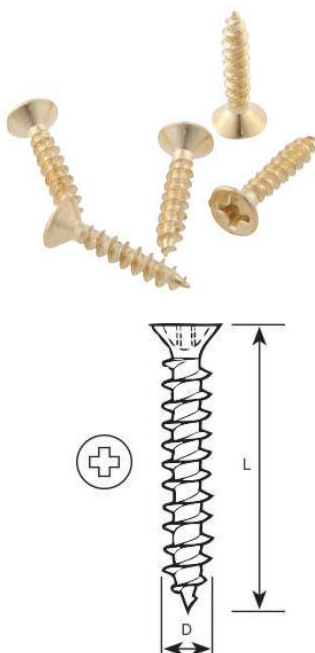

No 2 Phillips Drive

Part No	Description	Finish	Price /1	Price /10	Per
61.21.416.PH	4g x 16mm Particleboard Screw EB PH	EB	\$15.07	\$12.92	1000
61.21.516.PH	5g x 16mm Particleboard Screw EB PH	EB	\$16.94	\$14.52	1000

Euro Screw Countersunk - Phillips Drive

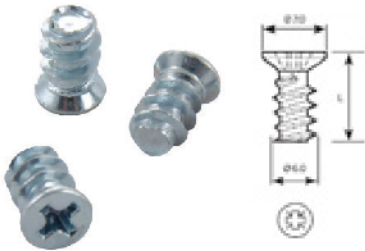

No 2 Phillips Drive

Part No	Description	Finish	Price /1	Price /10	Per
61.63.010 PH	6.3 x 10mm Euro Screws	NP	\$28.82	\$24.70	1000

Euro Screw Countersunk - Pozi Drive

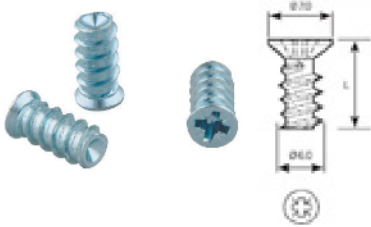

No 2 Pozi Drive

Part No	Description	Finish	Price /1	Price /10	Per
61.63.010 PZ	6.3 x 10mm Euro Screws	NP	\$28.82	\$24.70	1000

Assembly Screw

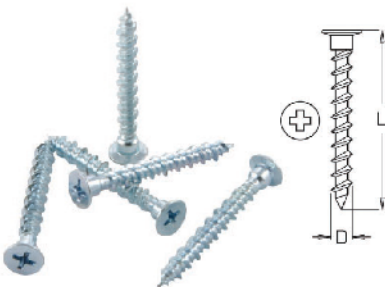

Part No	Description	Finish	Price /1	Price /10	Per
61.40.845.PH	4.0 x 45mm Assembly Screw PH	ZP	\$33.00	\$28.29	1000

COVER CAPS

15mm Self Adhesive Screw Caps



- Pack of 1000

Part No	Description	Finish	Price /1	Price/5	Per
71.40.000	Self Adhesive Cover Caps	WH	\$26.20	\$22.17	1000

Fastcap Self Adhesive Screw Caps



- 52 / card, 20 cards / box
- 14mm Ø

Part No	Description	Price /1	Price/20	Per
71.42.000	Fastcap Self Adhesive Caps - White	\$2.90	\$2.46	card
71.42.003	Fastcap Self Adhesive Caps - Black	\$4.80	\$3.60	card

Self Adhesive Screw Caps

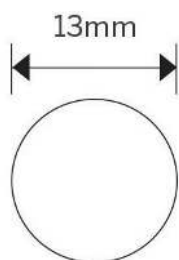

- 20 per card, 5 cards per pack
- 13mm Ø

Part No	Description	Finish	Price /1	Price/20	Per
71.43.Black	13mm Self Adhesive Caps	Black	\$8.56	\$7.90	100
71.43.Dark Cherry	13mm Self Adhesive Caps	Dark Cherry	\$8.56	\$7.90	100
71.43.Light Cherry	13mm Self Adhesive Caps	Light Cherry	\$8.56	\$7.90	100
71.43.Oak	13mm Self Adhesive Caps	Oak	\$8.56	\$7.90	100
71.43.Mahogany	13mm Self Adhesive Caps	Mahogany	\$8.56	\$7.90	100
71.43.Elm	13mm Self Adhesive Caps	Elm	\$8.56	\$7.90	100
71.43.Beech	13mm Self Adhesive Caps	Beech	\$8.56	\$7.90	100
71.43.Ash	13mm Self Adhesive Caps	Ash	\$8.56	\$7.90	100
71.43.White	13mm Self Adhesive Caps	White	\$8.56	\$7.90	100

Stem Caps



- Suits Capfit Screws
- Minimum order 1000

Part No	Description	Price /1	Price/10	Per
71.45.colour	Insert colour into part number - see colours as per chart	\$15.00	\$13.50	1000

COLOUR CHART

White	Off White	Crystal	Bone	Cream	Antique White	Magnolia
Almond Ivory	Marl Beige	Sahara Dune	Almond	Beige	Stone Beige	Rose Beige
Driftwood	Desert Dusk	Horizon Cream	Buff	Myrtlewood	Honeymaple	Mustard
Orange	Caramel	Suede	Coppertone (M)	Woodrose	Teak	Metallic Brown (M)
Mahogany	Sandalwood	Chocolate	Brown Bronze (M)	Hammersley	Weathered Copper	Sepia
Old Burgundy	Auburn	Redgum	Blaze	Red	Mt Olga Orange	Coral
Aubergine	Mulberry	Sunset	Rose Ash	Pink	Lilac	Greige
Heather	Fuschia	Apricot	Harvest	Banana	Yellow	Gold
Brass (M)	Copper (M)	Avocado	Bronze Olive	Anodised Bronze (M)	Heritage Green	Teal
Forest Green	Fern Green	Shadow	Sage	Pale Sage	Ocean Grey	Citrine
Indian Sage	Cactus	Aqua Blue	Cloud Blue	Blue Grey	Shadowart	Windsor Blue
Sky	Sea Blue	Aqua Sky	Turquoise	Reef Blue	Mill Blue	Caspian Blue
Space Blue	Royal Blue	Slate Blue	Black	Medium Slate	Charcoal	Wedgewood
Silver Grey (M)	Fog Grey	Light Grey	Morning Grey	Oyster Grey	Aluminium Tone	Mist Grey

Star Caps



- Minimum order 1000
- Suits Phillips Drive Screws

Part No	Description	Price /1	Price/10	Per
71.47. White	Phillips Drive Star Cap - White	\$15.00	\$13.50	1000
71.47.Black	Phillips Drive Star Cap - Black	\$15.00	\$13.50	1000

M4 Handle Screws

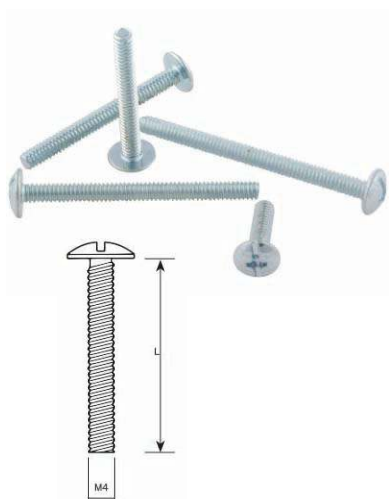

Part No	Description	Finish	Price /1	Price /10	Per
63.04.006	M4 x 6mm Handle Screw	ZP	\$3.89	\$3.18	100
63.04.008	M4 x 8mm Handle Screw	ZP	\$3.91	\$3.20	100
63.04.010	M4 x 10mm Handle Screw	ZP	\$3.94	\$3.22	100
63.04.012	M4 x 12mm Handle Screw	ZP	\$4.11	\$3.36	100
63.04.016	M4 x 16mm Handle Screws	ZP	\$4.25	\$3.48	100
63.04.020	M4 x 20mm Handle Screw	ZP	\$4.55	\$3.72	100
63.04.022	M4 x 22mm Handle Screw	ZP	\$4.79	\$3.92	100
63.04.025	M4 x 25mm Handle Screw	ZP	\$5.13	\$4.20	100
63.04.028	M4 x 28mm Handle Screw	ZP	\$5.23	\$4.28	100
63.04.032	M4 x 32mm Handle Screw	ZP	\$5.57	\$4.56	100
63.04.038	M4 x 38mm Handle Screw	ZP	\$6.09	\$4.98	100
63.04.041	M4 x 41mm Handle Screw	ZP	\$6.28	\$5.14	100
63.04.045	M4 x 45mm Handle Screw	ZP	\$6.38	\$5.22	100

C Series Brad



• Box 2500

Part No	Description	Finish	Price /1	Price /10	Per
63.16.020	C Series Brad 16g x 20mm	ZP	\$13.37	\$12.03	box
63.16.025	C Series Brad 16g x 25mm	ZP	\$14.45	\$13.00	box
63.16.030	C Series Brad 16g x 30mm	ZP	\$15.38	\$13.84	box
63.16.032	C Series Brad 16g x 32mm	ZP	\$16.30	\$14.67	box
63.16.035	C Series Brad 16g x 35mm	ZP	\$16.81	\$15.13	box
63.16.040	C Series Brad 16g x 40mm	ZP	\$19.38	\$17.44	box
63.16.045	C Series Brad 16g x 45mm	ZP	\$21.08	\$18.97	box
63.16.050	C Series Brad 16g x 50mm	ZP	\$21.49	\$19.34	box

C100 Series Brad



• Box 5000

Part No	Description	Finish	Price /1	Price /10	Per
63.18.020	C100 Series Brad 18g x 20mm	ZP	\$13.71	\$12.03	box
63.18.025	C100 Series Brad 18g x 25mm	ZP	\$16.01	\$13.00	box
63.18.030	C100 Series Brad 18g x 30mm	ZP	\$18.90	\$13.84	box
63.18.035	C100 Series Brad 18g x 35mm	ZP	\$21.19	\$14.67	box
63.18.040	C100 Series Brad 18g x 40mm	ZP	\$22.55	\$15.13	box
63.18.045	C100 Series Brad 18g x 45mm	ZP	\$25.43	\$17.44	box
63.18.050	C100 Series Brad 18g x 50mm	ZP	\$27.90	\$18.97	box

80 Series Staple



• Box 10,000

Part No	Description	Finish	Price /1	Price /10	Per
63.80.006	80 Series Staple 6mm	ZP	\$17.36	\$15.62	box
63.80.010	80 Series Staple 10mm	ZP	\$20.41	\$18.36	box
63.80.012	80 Series Staple 12mm	ZP	\$22.99	\$20.69	box
63.80.014	80 Series Staple 14mm	ZP	\$25.52	\$22.97	box

TOOLS

Metric Drill Bits



- HSS Titanium Nitride (Gold) Coated which increases the life of the drill
- Drills Metal, Wood & Plastic
- 135 degree split point allows for faster drilling and minimises wandering

Part No	Description	Price /1	Price /10	Per
77.00.010	1.0mm Jobber Drill (x2)	\$7.22	\$6.01	ea
77.00.015	1.5mm Jobber Drill (x2)	\$6.53	\$5.45	ea
77.00.020	2.0mm Jobber Drill (x2)	\$6.16	\$5.13	ea
77.00.025	2.5mm Jobber Drill (x2)	\$4.27	\$3.56	ea
77.00.030	3.0mm Jobber Drill (x2)	\$5.79	\$4.82	ea
77.00.035	3.5mm Jobber Drill	\$3.26	\$2.71	ea
77.00.040	4.0mm Jobber Drill	\$3.63	\$3.03	ea
77.00.045	4.5mm Jobber Drill	\$3.98	\$3.32	ea
77.00.050	5.0mm Jobber Drill	\$4.51	\$3.76	ea
77.00.055	5.5mm Jobber Drill	\$5.26	\$4.38	ea
77.00.060	6.0mm Jobber Drill	\$6.16	\$5.13	ea
77.00.065	6.5mm Jobber Drill	\$6.69	\$5.57	ea
77.00.070	7.0mm Jobber Drill	\$7.96	\$6.64	ea
77.00.075	7.5mm Jobber Drill	\$8.67	\$7.22	ea
77.00.080	8.0mm Jobber Drill	\$9.64	\$8.03	ea
77.00.085	8.5mm Jobber Drill	\$11.26	\$9.39	ea
77.00.090	9.0mm Jobber Drill	\$12.34	\$10.29	ea
77.00.095	9.5mm Jobber Drill	\$13.16	\$10.96	ea
77.00.100	10.0mm Jobber Drill	\$14.48	\$12.06	ea

Imperial Drill Bits



- HSS Titanium Nitride (Gold) Coated which increases the life of the drill
- Drills Metal, Wood & Plastic
- 135 degree split point allows for faster drilling and minimises wandering

Part No	Description	Price /1	Price /10	Per
77.01.100	1/16" Jobber Drill (x2)	\$6.53	\$5.45	ea
77.01.102	5/64" Jobber Drill (x2)	\$6.16	\$5.13	ea
77.01.104	3/32" Jobber Drill (x2)	\$6.16	\$5.13	ea
77.01.106	7/64" Jobber Drill (x2)	\$5.79	\$4.82	ea
77.01.108	1/8" Jobber Drill (x2)	\$5.94	\$4.95	ea
77.01.110	9/64" Jobber Drill	\$3.63	\$3.03	ea
77.01.112	5/32" Jobber Drill	\$3.63	\$3.03	ea
77.01.114	11/64" Jobber Drill	\$3.98	\$3.32	ea
77.01.116	3/16" Jobber Drill	\$4.33	\$3.61	ea
77.01.118	13/64" Jobber Drill	\$4.69	\$3.91	ea
77.01.120	7/32" Jobber Drill	\$5.43	\$4.53	ea
77.01.122	15/64" Jobber Drill	\$5.94	\$4.95	ea
77.01.124	1/4" Jobber Drill	\$6.34	\$5.28	ea
77.01.126	17/64" Jobber Drill	\$7.59	\$6.33	ea
77.01.128	9/32" Jobber Drill	\$8.34	\$6.95	ea
77.01.130	19/64" Jobber Drill	\$9.02	\$7.52	ea
77.01.132	5/16" Jobber Drill	\$9.42	\$7.85	ea
77.01.134	21/64" Jobber Drill	\$11.24	\$9.37	ea
77.01.136	11/32" Jobber Drill	\$12.87	\$10.73	ea
77.01.138	23/64" Jobber Drill	\$13.42	\$11.18	ea
77.01.140	3/8" Jobber Drill	\$13.62	\$11.35	ea
77.01.142	25/64" Jobber Drill	\$14.48	\$12.06	ea
77.01.144	13/32" Jobber Drill	\$16.21	\$13.51	ea
77.01.146	27/64" Jobber Drill	\$17.73	\$14.78	ea
77.01.148	7/16" Jobber Drill	\$18.46	\$15.38	ea
77.01.150	29/64" Jobber Drill	\$22.09	\$18.41	ea
77.01.152	15/32" Jobber Drill	\$22.53	\$18.77	ea
77.01.154	31/64" Jobber Drill	\$24.40	\$20.33	ea
77.01.156	1/2" Jobber Drill	\$24.95	\$20.79	ea

Metric Bull Pack Drills



- HSS Titanium Nitride (Gold) Coated which increases the life of the drill
- Drills Metal, Wood & Plastic
- 135 degree split point allows for faster drilling and minimises wandering

Part No	Description	Price /1	Price /10	Per
77.10.015	1.5mm Jobber Drill Bit - pk 10	\$14.48	\$13.03	ea
77.10.020	2.0mm Jobber Drill Bit - pk 10	\$15.77	\$14.19	ea
77.10.025	2.5mm Jobber Drill Bit - pk 10	\$16.50	\$14.85	ea
77.10.030	3.0mm Jobber Drill Bit - pk 10	\$20.17	\$18.15	ea
77.10.032	3.2mm Jobber Drill Bit - pk 10	\$20.72	\$18.64	ea
77.10.035	3.5mm Jobber Drill Bit - pk 10	\$21.63	\$19.47	ea
77.10.040	4.0mm Jobber Drill Bit - pk 10	\$24.02	\$21.61	ea
77.10.045	4.5mm Jobber Drill Bit - pk 10	\$31.35	\$28.21	ea
77.10.050	5.0mm Jobber Drill Bit - pk 10	\$33.18	\$29.86	ea

Imperial Bull Pack Drills



- HSS Titanium Nitride (Gold) Coated which increases the life of the drill
- Drills Metal, Wood & Plastic
- 135 degree split point allows for faster drilling and minimises wandering

Part No	Description	Price /1	Price /10	Per
77.10.104	3/32" drill bits - pk 10	\$16.50	\$14.85	ea
77.10.106	7/64" drill bit - pk 10	\$17.42	\$15.67	ea
77.10.108	1/8" Drill bit - pk 10	\$20.17	\$18.15	ea
77.10.110	9/64" Drill Bit - pk 10	\$22.73	\$20.46	ea

Metric Drill Set



- HSS Titanium Nitride (Gold) Coated which increases the life of the drill
- Drills Metal, Wood & Plastic
- 135 degree split point allows for faster drilling and minimises wandering

Part No	Description	Price /1	Price /10	Per
77.60.019	19pce Metric Slimbox Drill Set 1.0-10.0mm	\$84.26	\$75.83	ea
77.60.029	29pce Imperial Slimbox Drill Set 1/16-1/2in	\$199.82	\$179.82	ea

TCT Countersink Drill Bit



- Tungsten Carbide Countersink with HSS Drill Bit

Part No	Description	Price /1	Price /10	Per
77.20.106	7/64" TCT CSK Drill Bit	\$30.80	\$27.72	ea
77.20.108	1/8" TCT CSK Drill Bit	\$30.98	\$27.88	ea
77.20.110	9/64" TCT CSK Drill	\$31.17	\$28.05	ea

Driver Bits



Part No	Description	Price /1	Price /10	Per
77.35.000	75mm Magnetic Bit Holder	\$11.30	\$9.40	ea
77.35.032	PH2 x 50mm Phillips Bit - 10	\$11.70	\$10.53	ea
77.35.036	PZ2 x 50mm Phillips Bit - 10	\$11.70	\$10.53	ea
77.35.042	PH2 x 25mm Pozi Bit - 10	\$6.03	\$5.43	ea
77.35.046	PZ2 x 25mm Pozi Bit - 10	\$7.37	\$6.63	ea

Jigsaw Blades



- Ideal for precise straight cuts in hardwoods, softwoods, plywood & plastics
- Euro Shank
- 10 TPI
- 100mm overall length

Part No	Description	Price /1	Price /10	Per
77.23.810	Jigsaw Blades - 5 per card	\$15.36	\$12.80	card

Planer Blades



- Suits most electric planes

Part No	Description	Price /1	Price /10	Per
77.23.825	TCT Planer Blades / Pr	\$14.40	\$11.98	pr

Thingamejig Scribing Tool



- Scribes laminates, stone, timber, veneers and more
- Single handed use
- Ability to accurately retrace your lines

Part No	Description	Price /1	Price /10	Per
77.30.500	Thingamejig Scribing Tool	\$75.00	\$71.25	pr