

GENERAL HARDWARE



GENERAL HARDWARE

Cinetto Bi-folding Door Systems	4
Round Lazy Susan Swivel	5
Wardrobe Fittings	6-7
Flush Pulls	8
Hand Rail Brackets	9
Hat & Coat Hooks	10
SHELF HARDWARE	
Slot Stripping & Brackets	10-11
Shelf Supports	11
Castors	12
Furniture & Table Legs	13
Extension Table Hardware	14
Bed Brackets	15
Hinges	16
CATCHES	17-19
Barrel Bolts	20
Locks	21
Cable Entry Covers	22
Connecting Systems	23
Door Buffers	24
Tape	25
White Timber Rail	25
Cotton Rags	25

CINETTO BI-FOLDING DOOR SYSTEM

- Super smooth gliding with ball bearing rollers on sliding block
- Systems for doors up to 50kg
- Suits timber or aluminium framed glass doors
- Left hand roller & hinge moves to left when opening
- Right hand roller & hinge moves to right when opening
- Material: Aluminium

Cinetto Track



- Material: Aluminium

Part No	Description	Finish	Price /1	Price/5	Per
CT1200C	1200mm Cinetto Track	ALU	\$44.17	\$38.28	ea
CT2400C	2400mm Cinetto Track	ALU	\$99.37	\$86.12	ea

Cinetto Roller & Hinge - 25kg



Part No	Description	Finish	Price /1	Price/5	Per
CTS.25L	25kg Cinetto Roller & Hinge LH	ZP	\$48.59	\$42.11	ea
CTS.25R	25kg Cinetto Roller & Hinge RH	ZP	\$48.59	\$42.11	ea

Cinetto Roller & Hinge - 50kg



Part No	Description	Finish	Price /1	Price/5	Per
CTS.50L	50kg Cinetto Roller & Hinge LH	ZP	\$57.64	\$49.95	ea
CTS.50R	50kg Cinetto Roller & Hinge RH	ZP	\$57.64	\$49.95	ea

Cinetto Centre Bi-Fold Hinge



Part No	Description	Finish	Price /1	Price/10	Per
CSHC	Cinetto Centre Bi-fold Hinge	ZP	\$2.44	\$2.09	ea

Twin-cup Centre Bi-fold Hinge



- Alternative adjustable centre hinge. Can be used instead of CSHC
- 35mm Ø boring size

Part No	Description	Finish	Price /1	Price/10	Per
ACHB35	Twin-cup Centre Bi-fold Hinge	ZP	\$9.68	\$8.30	ea

Cinetto Hinge & Slide Cover



Part No	Description	Finish	Price /1	Price/10	Per
CTSC	Cinetto Hinge & Slide Cover	GY	\$9.05	\$7.85	ea

Round Lazy Susan Swivel



- 8mm high

Part No	Description	Finish	Price /1	Price/10	Per
71.80.300	300mm Round Lazy Susan Swivel	GY	\$29.20	\$26.30	ea

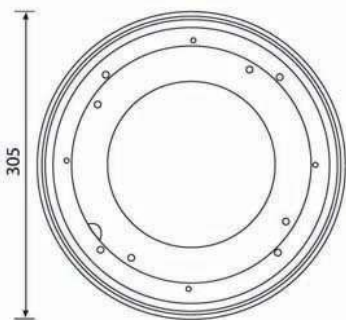

WARDROBE FITTINGS

Round Hanging Rod



Part No	Description	Finish	Price /1	Price/10	Per
75.50.019	19mm x 3600mm	CP	\$19.05	\$15.88	ea
75.50.025	25mm x 3600mm	CP	\$21.89	\$18.24	ea

Aluminium Oval Hanging Rod



- 30mm x 15mm

Part No	Description	Finish	Price /1	Price/10	Per
75.50.000	Oval Tube 30 x 15 x 3600	ALU	\$22.82	\$19.31	ea
75.50.001	Oval Tube 30 x 15 x 3600	MB	\$22.82	\$19.31	ea
75.50.006	Oval Tube 30 x 15 x 3600	CP	\$22.82	\$19.31	ea

End Flange for Round Hanging Rod



Part No	Description	Finish	Price /1	Price/50	Per
75.10.019	19mm Ø end flange	CP	\$1.29	\$0.86	ea
75.10.025	25mm Ø end flange	CP	\$1.43	\$1.19	ea

Flange for Oval Hanging Rod



Part No	Description	Finish	Price /1	Price/50	Per
75.09.000	Oval End Flange	MB	\$2.38	\$2.20	ea
75.10.000	Oval End Flange	SC	\$1.54	\$1.03	ea
75.11.000	Oval End Flange	CP	\$2.38	\$2.20	ea

End Pillar for Round Hanging Rod



- For round tube

Part No	Description	Finish	Price /1	Price/50	Per
75.15.019	19mm Ø end pillar	CP	\$1.90	\$1.60	ea
75.15.025	25mm Ø end pillar	CP	\$2.15	\$1.80	ea

End Pillar for Oval Hanging Rod



Part No	Description	Finish	Price /1	Price/50	Per
75.15.000	Oval end pillar	MB	\$2.68	\$2.47	ea
75.16.000	Oval end pillar	CP	\$2.68	\$2.47	ea
75.17.000	Oval end pillar	SC	\$2.68	\$2.47	ea

Centre Pillar for Hanging Rod



- For round tube

Part No	Description	Finish	Price /1	Price/50	Per
75.20.019	19mm Ø centre pillar	CP	\$1.90	\$1.60	ea
75.20.025	25mm Ø centre pillar	CP	\$2.44	\$2.25	ea

Centre Pillar for Hanging Rod



Part No	Description	Finish	Price /1	Price/50	Per
75.19.000	Oval centre pillar	MB	\$2.68	\$2.47	ea
75.20.000	Oval centre pillar	CP	\$2.68	\$2.47	ea
75.21.000	Oval centre pillar	SC	\$1.76	\$1.62	ea

FLUSH PULLS

Oval Flush Pull



- 102mm CTC x 114mm L x 6mm D x 34mm W

Part No	Description	Finish	Price /1	Price/20	Per
45.90.006	Oval Flush Pull	CP	\$7.95	\$5.85	ea
45.90.015	Oval Flush Pull	SC	\$7.95	\$5.85	ea

Rectangle Flush Pull



- 102mm CTC x 114mm L x 6mm D x 34mm W

Part No	Description	Finish	Price /1	Price/20	Per
45.92.006	Rectangle Flush Pull	CP	\$7.95	\$5.85	ea
45.92.008	Rectangle Flush Pull	PG	\$7.95	\$5.85	ea
45.92.015	Rectangle Flush Pull	SC	\$7.95	\$5.85	ea

Slide Flush Pull



- 37mm W x 10mm D
- All sizes available in Matte Black & Satin Stainless Steel

Part No	Description	Cut-out	Finish	Price /1	Per
530.150.04	150mm Slide Flush Pull	125 x 30mm	MB	\$34.10	ea
530.150.07	150mm Slide Flush Pull	125 x 30mm	SS	\$27.50	ea
530.200.04	200mm Slide Flush Pull	175 x 30mm	MB	\$40.30	ea
530.200.07	200mm Slide Flush Pull	175 x 30mm	SS	\$32.50	ea
530.250.04	250mm Slide Flush Pull	225 x 30mm	MB	\$46.50	ea
530.250.07	250mm Slide Flush Pull	225 x 30mm	SS	\$37.50	ea
530.300.04	300mm Slide Flush Pull	275 x 30mm	MB	\$52.90	ea
530.300.07	300mm Slide Flush Pull	275 x 30mm	SS	\$42.65	ea

Concealed Fix Oval Flush Pull



- 120x40mm x 10mm D

Part No	Description	Finish	Price /1	Price/10	Per
524.120.07	Oval Flush Pull	SS	\$11.85	\$10.66	ea

HAND RAIL BRACKETS

Concealed Fix Hand Rail Bracket



- Concealed fix hand rail bracket with lag screw
- 55mm base diameter x 80mm projection to centre of handrail
- Suits 50mm diameter rail
- Also suitable for use with flat base rail

Part No	Description	Finish	Price /1	Price /20	Per
443.SC	Hand Rail Bracket	Satin	\$22.95	\$20.65	ea
443.PC	Hand Rail Bracket	PC	\$22.95	\$20.65	ea
443.MB	Hand Rail Bracket	MB	\$22.95	\$20.65	ea

Visible Fix Hand Rail Bracket



- 55mm base diameter x 80mm projection to centre of handrail
- Suits 50mm diameter rail
- Also suitable for use with flat base rail

Part No	Description	Finish	Price /1	Price /20	Per
444.SP	Hand Rail Bracket	Satin	\$19.70	\$17.73	ea
444.PC	Hand Rail Bracket	PC	\$19.70	\$17.73	ea
444.MB	Hand Rail Bracket	MB	\$19.70	\$17.73	ea

Flat Top Concealed Fix Hand Rail Bracket with Cover Plate



- 55mm base diameter x 80mm projection to centre of handrail
- Suits 50mm diameter rail
- Flat Top
- Complies with Australian Standard AS1428.1-2001

Part No	Description	Finish	Price /1	Price /20	Per
SS80FT.SS	Flat Top Hand Rail Bracket	SSS	\$35.55	\$32.00	ea

HAT AND COAT HOOKS

School Pattern Hat & Coat Hook



Part No	Description	Finish	Price /1	Price/25	Per
71.50.015	80mm Hat & Coat Hook	BRN	\$6.35	\$5.40	ea
71.50.020	80mm Hat & Coat Hook	CP	\$6.35	\$5.40	ea

Woronora Hook



Part No	Description	Price /1	Price/25	Per
71.50.025	Wrought Iron Hat & Coat Hook	\$7.35	\$6.52	ea

SHELF STRIPPING/SUPPORTS

Single Slot Stripping

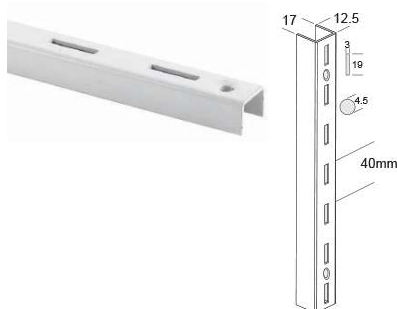

Part No	Description	Finish	Price /1	Price /10	Per
74.20.120	1200mm length	WH	\$8.97	\$7.68	ea
74.20.180	1800mm length	WH	\$13.49	\$11.57	ea
74.20.210	2100mm length	WH	\$14.41	\$12.35	ea
74.20.240	2400mm length	WH	\$15.95	\$13.67	ea

Standard Bracket - 2 Lug



Part No	Description	Finish	Price /1	Price /20	Per
74.02.200	200mm bracket	WH	\$4.22	\$3.61	ea
74.02.250	250mm bracket	WH	\$4.68	\$4.01	ea
74.02.300	300mm bracket	WH	\$4.97	\$4.26	ea

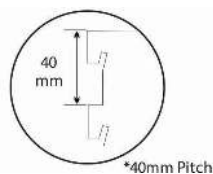

Standard Bracket - 3 Lug

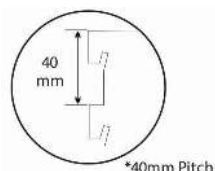

Part No	Description	Finish	Price /1	Price /20	Per
74.03.350	350mm bracket	WH	\$5.54	\$4.75	ea
74.03.400	400mm bracket	WH	\$6.73	\$5.77	ea
74.03.450	450mm bracket	WH	\$7.13	\$6.11	ea

Shelf Rests



- Clear Plastic
- Removable grommets

Part No	Description	Finish	Price /1	Price /50	Per
74.00.010	End Clip	CLR	\$0.66	\$0.57	ea
74.00.110	Centre clip	CLR	\$0.84	\$0.72	ea

Standard Shelf Support

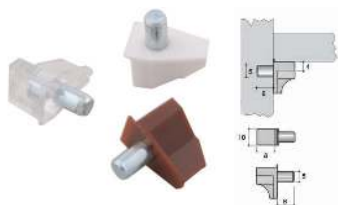

- Plastic with metal pin
- Drill Size 5mm

Part No	Description	Finish	Price /1	Price /5	Per
71.75.001	Shelf support	WH	\$37.77	\$34.86	1000
71.75.002	Shelf support	CLR	\$37.77	\$34.86	1000
71.75.003	Shelf Support	BRWN	\$62.65	\$57.83	1000
71.75.004	Shelf Support	BLK	\$44.24	\$40.84	1000

Solid Brass Shelf Support

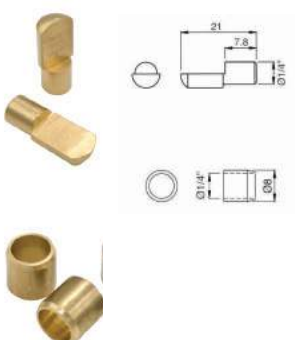

- Drill Size 8mm (bush)
- Drill depth 8mm (bush)

Part No	Description	Finish	Price /1	Price /10	Per
71.75.005	Brass Pin	Brass	\$42.52	\$39.24	100
71.75.006	Brass Bush	Brass	\$17.01	\$15.70	100

CASTORS

Heavy Duty Nylon Castor With Polyurethane Tread



- 60mm Ø wheel
- 90kg Load Rating

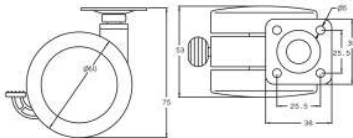

Part No	Description	Finish	Price /1	Price/50	Per
43.10.060	60mm castor	BL/SIL	\$6.50	\$5.50	ea
43.11.060	60mm castor with brake	BL/SIL	\$8.10	\$6.85	ea

Heavy Duty Swivel Castor, Polyurethane Wheel



- 50mm Ø wheel
- 40kg Load Rating

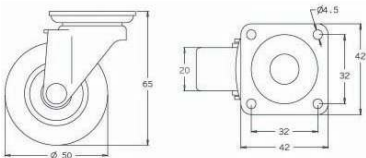

Part No	Description	Finish	Price /1	Price/50	Per
43.40.050	50mm castor	GY	\$7.36	\$6.23	ea
43.41.050	50mm castor with brake	GY	\$8.92	\$7.55	ea



- 75mm Ø wheel
- 95kg Load Rating

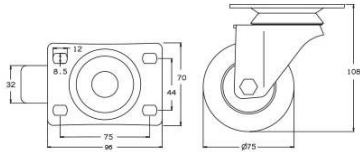

Part No	Description	Finish	Price /1	Price/20	Per
43.50.075	75mm castor	GY	\$30.74	\$26.01	ea
43.51.075	75mm castor with brake	GY	\$38.16	\$32.29	ea



- 100mm Ø wheel
- 110kg Load Rating

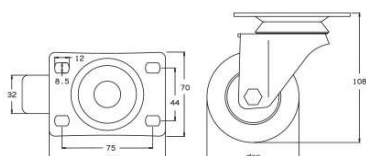

Part No	Description	Finish	Price /1	Price/20	Per
43.50.100	100mm castor	GY	\$34.35	\$29.32	ea
43.51.100	100mm castor with brake	GY	\$39.00	\$33.30	ea

FURNITURE & TABLE LEGS

Adjustable Leg



- 150-180mm adjustable height
- Stainless Steel

Part No	Description	Finish	Price /1	Price/25	Per
47.20.180	Adjustable Leg	SS	\$15.81	\$13.18	ea

60mm Ø Table Leg

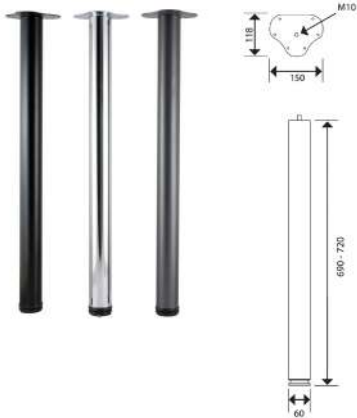

- 690mm - 720mm Height Adjustable

Part No	Description	Finish	Price /1	Price/20	Per
49.20.690	Screw on Table Leg	PC	\$18.20	\$15.50	ea
49.24.690	Screw on Table Leg	BL	\$18.20	\$15.50	ea
49.15.690	Screw on Table Leg	SN	\$18.20	\$15.50	ea

60mm Ø Table Leg



- Height Adjustable

Part No	Description	Finish	Price /1	Price/20	Per
49.20.870	870 - 900mm High	PC	\$29.30	\$27.04	ea
49.24.870	870 - 900mm High	BL	\$29.30	\$27.04	ea

Cabinet Plinth Leg



- Height Adjustable 100-165mm
- Screw On

Part No	Description	Finish	Price /1	Price/80	Per
AKLS	Cabinet Plinth Leg	BL	\$1.56	\$1.39	ea

EXTENSION TABLE HARDWARE

750mm Extension Table Slide

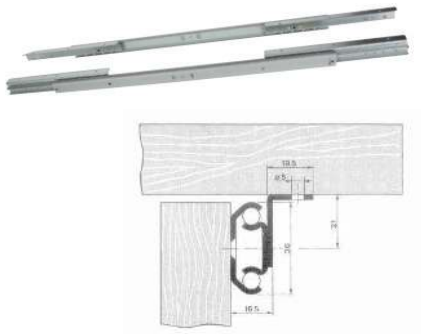

- Closed size plus maximum leaf sizes equals open size

Part No	Description	1-9	10 +	Per
ETS750	750mm Extension Table Slide	\$65.87	\$56.46	rail

Table Dowel Guide & Bush



- Drill size 8mm Ø

Part No	Description	1-99	100+	Per
TD8	Table Dowel Guide 8mm	\$0.58	\$0.49	ea
TDB8	Table Dowel Guide Bush	\$0.58	\$0.49	ea

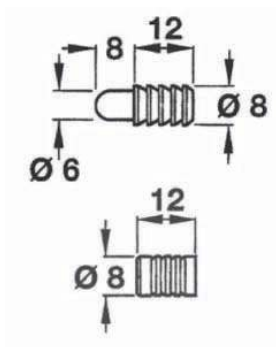

BED BRACKETS

Heavy Duty Bed Brackets



- Supplied with connecting screws & 5mm allen key

Part No	Description	Finish	Price /1	Price /25	Per
71.15.120	120mm bed bracket	YZ	\$13.90	\$11.59	Set
71.15.085	85mm bed bracket	YZ	\$13.70	\$11.15	Set

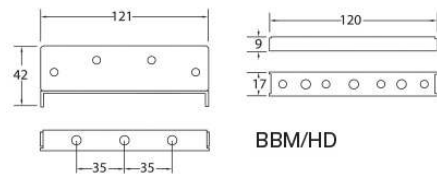
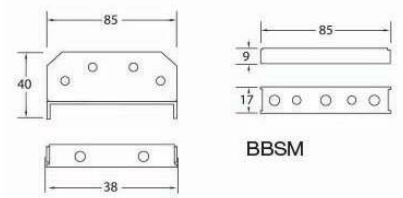

Centre Rail Bracket



- 2 sets required per rail

Part No	Description	Finish	Price	Price/100	Per
71.15.000	Centre rail bracket	YZ	\$2.20	\$1.83	Set

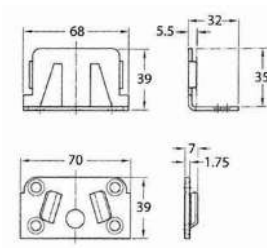

HINGES

Solid Brass Butt Hinges

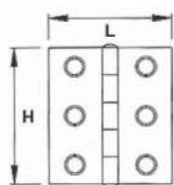

- Solid Brass - Raw Finish
- Sold Per Pair

Part No	Description	Finish	Price /1	Price/20	Per
19.00.038	38 x 22mm	RB	\$3.50	\$3.23	pr
19.00.050	50 x 28mm	RB	\$3.94	\$3.64	pr
19.00.063	63 x 35mm	RB	\$5.10	\$4.70	pr

Stainless Steel Hipline Hinge - Centre Pin



Part No	Description	Finish	Price /1	Price/20	Per
SSHH63 - F	63 x 25 x 1.5mm	SS	\$5.05	\$4.55	ea
SSHH89 - F	89 x 36 x 2.0mm	SS	\$6.30	\$5.65	ea

Stainless Steel Fast Fix Bearing Hinge



- For timber frame to timber door

Part No	Description	Finish	Price /1	Price/20	Per
SSHH100T-F	102 x 49 x 2.5mm Fastfix Hinge	SS	\$9.00	\$6.00	ea

Piano Hinge



- 32mm Width
- 25m Roll

Part No	Description	Finish	Price /1	Price /5	Per
19.70.008	Piano Hinge	EB	\$112.51	\$103.86	roll
19.70.005	Piano Hinge	NP	\$100.32	\$92.60	roll
19.70.003	Piano Hinge	FB	\$101.46	\$93.65	roll

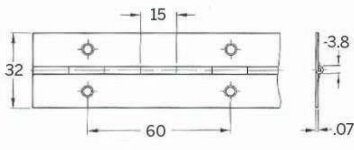

CATCHES

Caravan Catch

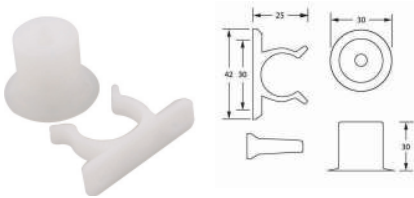

Part No	Description	Finish	Price /1	Price/50	Per
71.10.131	Caravan Catch	WH	\$0.86	\$0.72	ea

Daisy Catch



Part No	Description	Finish	Price /1	Price/50	Per
71.10.135	Daisy Catch	WH	\$4.18	\$3.86	ea

Corna Side Mount Catch

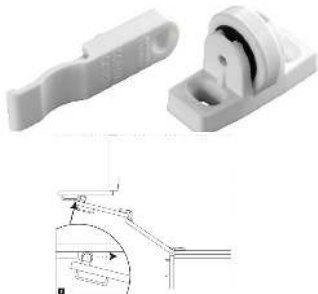

- Prevents dropping of bi-fold corner doors

Part No	Description	Finish	Price /1	Price/25	Per
71.10.140	Side Mount Corner Catch	WH	\$2.99	\$2.76	ea

Caravan Latch



- Push latch with knob
- For door thickness 18 - 24mm or use 71.10.401 for 15-17mm doors
- 25mm Ø

Part No	Description	Finish	Price /1	Price/20	Per
71.10.400	Caravan Latch	NP	\$15.42	\$14.23	ea

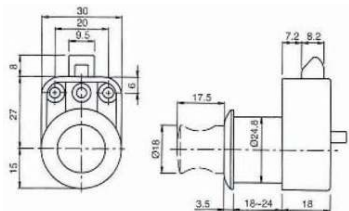

- 3mm spacer for 15 - 17mm door

Part No	Description	Finish	Price /1	Price/20	Per
71.10.401	3mm Spacer	BL	\$1.18	\$1.08	ea

Short Push Catch - 14mm throw



- Short version
- 14 mm throw
- 6 mm Adjustment
- Concealed use as standard
- For surface mounting, use with adapter housing
- Magnet version is supplied in a kit with both screw and stick on striker plates
- Finish: White (WH)

Part No	Description	Finish	1-9	10 +	Per
71.12.102	Short Push Catch - with buffer	WH	\$3.96	\$3.63	ea
71.12.152	Short Push Catch - with magnet	WH	\$5.36	\$4.91	ea

Long Push Catch - 37mm throw



- Long version
- 37 mm throw
- 6 mm Adjustment
- Concealed use as standard
- For surface mounting, use with adapter housing
- Magnet version is supplied in a kit with both screw and stick on striker plates
- Finish: White (WH)

Part No	Description	Finish	1-9	10 +	Per
71.12.202	Long Push Catch - with buffer	WH	\$4.32	\$3.96	ea
71.12.252	Long Push Catch - with magnet	WH	\$5.66	\$5.19	ea

Short Push Catch Housing



- To suit the K-Push Tech short version
- For surface mounting, use with K-Push Tech short version push catches
- Finish: White (WH)

Part No	Description	Finish	1-9	10 +	Per
71.12.107	Short Push Catch Housing	WH	\$0.90	\$0.83	ea

Long Push Catch Housing



- To suit the K-Push Tech long version
- For surface mounting, use with K-Push Tech long version push catches
- Finish: White (WH)

Part No	Description	Finish	1-9	10 +	Per
71.12.207	Long Push Catch Housing	WH	\$0.96	\$0.88	ea

BARREL BOLTS

Straight Barrel Bolt



Part No	Description	Finish	1-9	10 +	Per
71.72.060	100mm Barrel Bolt	SC	\$11.38	\$10.23	ea

Offset Barrel Bolt



Part No	Description	Finish	1-9	10 +	Per
71.72.120	100mm Offset Barrel Bolt	SC	\$13.65	\$12.28	

LOCKS

Drawer Lock Housing



- Suits panels up to 20mm thick
- Exchangeable Cylinder must be ordered separately

Part No	Description	Finish	Price /1	Price/20	Per
23.00.100V	Drawer Lock Housing - Vertical Bolt Projection	NP	\$5.30	\$4.80	ea

Cupboard Lock Housing



Left



Right

- Suits panels up to 20mm thick
- Exchangeable Cylinder must be ordered separately

Part No	Description	Finish	Price /1	Price/20	Per
23.00.150L	Cupboard Lock Housing Left Edge Bolt Projection	NP	\$5.30	\$4.80	ea
23.00.150R	Cupboard Lock Housing Right Edge Bolt Projection	NP	\$5.30	\$4.80	ea

Exchangeable Lock Cylinders

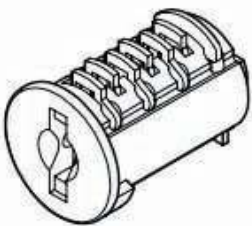

Part No	Description	Finish	Price /1	Price/20	Per
23.00.004	Exchangeable Lock Cylinder KA004	NP	\$4.95	\$4.45	ea
23.00.008	Exchangeable Lock Cylinder KA008	NP	\$4.95	\$4.45	ea
23.00.012	Exchangeable Lock Cylinder KA012	NP	\$4.95	\$4.45	ea
23.00.999	Exchangeable Lock Cylinder KD	NP	\$4.95	\$4.45	ea

Fixed Cylinder Cam Locks



- Ideal for use on drawers and cupboards

Part No	Description	Finish	Price /1	Price/20	Per
23.22.028	22mm Cam Lock KA	NP	\$11.20	\$10.08	ea
23.44.036	32mm Camlock KA036	NP	\$11.20	\$10.08	ea

Master Key

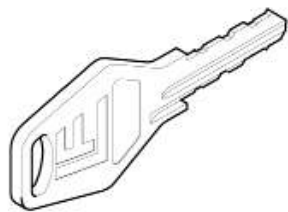

- Operates all locks without removing the barrel
- Yellow Tag

Part No	Description	Finish	Price /1	Price/5	Per
23.37.005	Master Key	NP	\$16.00	\$14.40	ea

Assembly Key

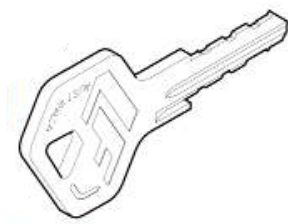

- Fits or removes a barrel from the housing
- Blue Tag

Part No	Description	Finish	Price /1	Price/5	Per
23.37.010	Assembly Key	NP	\$16.00	\$14.40	ea

Lock Striker Plate



- 30mm W x 9mm H

Part No	Description	Finish	Price	Price/20	Per
23.10.000	Striker Plate	NP	\$0.73	\$0.63	ea

CABLE ENTRY COVERS

Plastic Cable Entry Covers

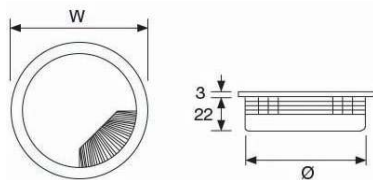

Part No	Description	Finish	Price /1	Price/100	Per
71.60.010	60mm Cable Entry Cover	BR	\$1.10	\$0.72	ea
71.60.020	60mm Cable Entry Cover	GY	\$1.10	\$0.72	ea
71.60.030	60mm Cable Entry Cover	BL	\$1.10	\$0.72	ea
71.60.040	60mm Cable Entry Cover	WH	\$1.10	\$0.72	ea
71.60.050	60mm Cable Entry Cover	BGE	\$1.10	\$0.72	ea
71.80.010	80mm Cable Entry Cover	BR	\$1.55	\$0.97	ea
71.80.020	80mm Cable Entry Cover	GY	\$1.55	\$0.97	ea
71.80.030	80mm Cable Entry Cover	BL	\$1.55	\$0.97	ea
71.80.040	80mm Cable Entry Cover	WH	\$1.55	\$0.97	ea
71.80.050	80mm Cable Entry Cover	BGE	\$1.55	\$0.97	ea

CONNECTING SYSTEMS

Door Magnets



Part No	Description	Finish	Price /1	Price/20	Per
1180	25mm x 7mm	SS	\$19.00	\$17.10	pair

Corner Bracket



Part No	Description	Finish	Price /1	Price/500	Per
71.15.025	25mm x 25mm	ZP	\$0.20	\$0.13	ea
71.15.038	38mm x 38mm	ZP	\$0.44	\$0.29	ea
71.15.050	50mm x 50mm	ZP	\$0.71	\$0.48	ea

Figure 8 Table Clip



Part No	Description	Finish	Price /1	Price/500	Per
71.15.105	Figure 8 Table Clip	ZP	\$0.22	\$0.16	ea

Quick Clips



- 100/ Bag

Part No	Description	Finish	Price /1	Price/10	Per
71.15.100	Quick Clip	WH	\$38.50	\$35.54	100

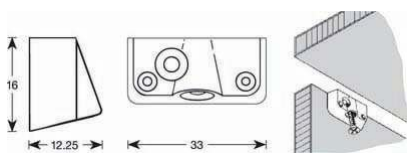

DOOR BUFFERS

Self Adhesive White Foam Buffers



- 12mm diameter x 3mm thick
- 1000 / box

Part No	Description	Finish	Price /1	Price /5	Per
71.30.115	Foam buffers	WH	\$40.77	\$37.64	1000

Self Adhesive Clear Bump-ons

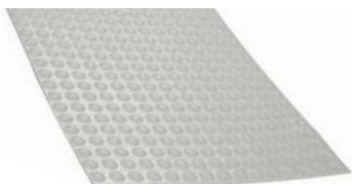

Part No	Description	Finish	Price /1	Price /12	Per
71.30.085	8.5mm x 2.2mm - 450/sheet	CLR	\$27.30	\$25.20	sheet
71.30.064	6.4mm x 1.6mm - 578/sheet	CLR	\$35.60	\$32.86	sheet

TAPE

Masking Tape



Part No	Description	Finish	Price /1	Price /24	Per
71.85.019	19mm x 50m	WH	\$1.84	\$1.60	ea
71.85.025	25mm x 50m	WH	\$2.75	\$2.38	ea
71.85.038	38mm x 50m	WH	\$4.44	\$3.85	ea
71.85.050	50mm x 50m	WH	\$5.33	\$4.62	ea

PVT Duct/Joining Tape



Part No	Description	Finish	Price /1	Price /24	Per
71.86.048	48mm x 20m	GY	\$2.91	\$2.52	ea

White Timber Rail



- 42 x 18mm
- 3.6 metres long
- 15 lengths per pack

Part No	Description	Finish	Price /1	Per
71.18.360	White Timber Rail	WH	\$135.00	Pack

White Cotton Rags



Part No	Description	Price /1	Price /5	Per
65.10.000	White Cotton Rags - 10kg	\$46.67	\$41.18	Bag